

4HWF SERIES POWER WINCHES

Thern 4HWF series power winches feature helical/worm gearing making them ideal for applications requiring secure load control and accurate positioning. The enclosed, direct-drive gearing design delivers dependable operation and helps reduce maintenance, while a modular design means we can easily customize these winches to meet your exact specifications.

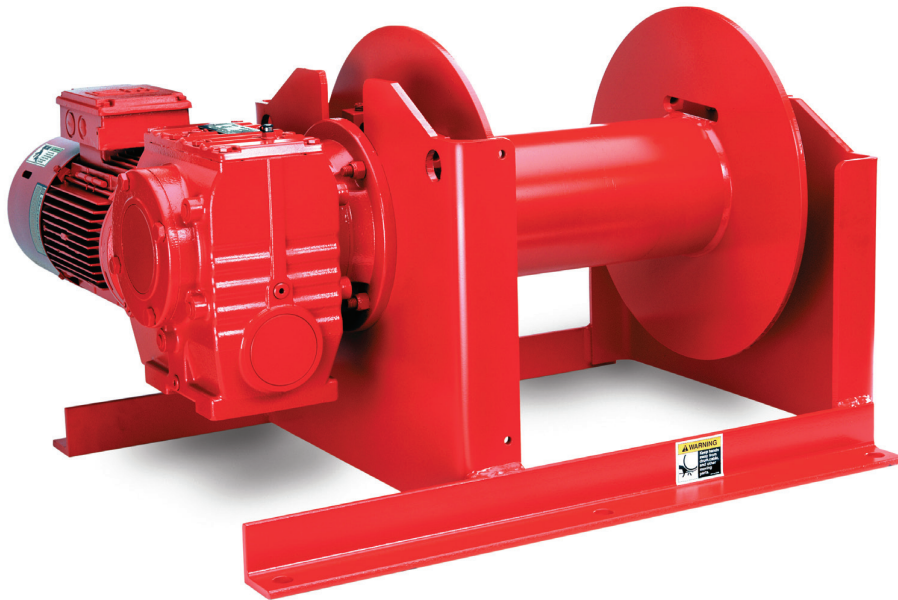

FLANGE STYLE ROLLER BEARINGS are self-aligning bearings with cast housing to maintain smooth drum rotation.

WELDED STEEL DRUM with outside flange anchors allow uniform winding and help extend life of wire rope. Anchors allow cable to be over wound or under wound from either side of the drum.

EXTENDED SOLID STEEL DRUM SHAFT for uniform loading.

WIRE ROPE ASSEMBLIES sold separately per customer request.

FLANGE MOUNTED MOTOR is a 230/460 volt 3 phase motor, 60 cycle, IP 55, TEFC severe duty, reversible, class F insulated, continuous duty brakemotor.

Standard motors comply with relevant standards including NEMA, MG1, ANSI, CSA, IEC and ABS.

LOAD HOLDING MOTOR DISC BRAKE is spring set, electrically released for positive load control.

DIRECT DRIVE GEAR REDUCERS, comprised of helical/worm gears, deliver lower efficiencies from 65% to 76% making winches well suited for applications requiring secure load control and accurate positioning.

The heat treated helical/worm gear set provides improved durability and operates in an oil bath, enclosed in a high strength cast iron gearcase, SAE class 30. Double-lip oil seals keep oil in and contaminants out. Large capacity bearings ensure long life. Speed reducers meet AGMA standards.

ANSI B30.7 COMPLIANCE is available. Please contact the factory.

2 YEAR "MOVE IT WITH CONFIDENCE" LIMITED WARRANTY leads the industry.

4HWF SERIES POWER WINCHES

	HP	Load Rating	Line Speed
4HWF1M	1.5 - 2	1,500 lb	25 - 35 fpm
4HWF2M	2 - 3	2,000 lb	25 - 35 fpm
4HWF4M	3 - 5	4,000 lb	25 - 35 fpm
4HWF6M	5 - 7.5	6,000 lb	25 - 35 fpm
4HWF8M	7.5 - 10	8,000 lb	25 - 35 fpm

OPTIONS AND ACCESSORIES

DRUM MODIFICATIONS (A) include grooved drums, multiple compartment drums and modified drum widths and diameters.

WINCH MOUNTING OPTIONS include base, wall or under hung installation.

CABLE PRESSURE BARS (B) help maintain uniform winding of wire rope.

LIMIT SWITCHES (C) provide secondary shut-off for load travel in one or two directions.

MOTOR OPTIONS include air or hydraulic, voltage or phase changes, IP 65, class F or H insulated, multi-speed operation.

DUTY RATINGS include IEEE 45 marine duty, tropical duty, severe duty and explosion proof ratings.

BRAKE OPTIONS include over-speed, caliper style, band, and more.

CONTROLS (D) are available in a wide range of standard and custom configurations for single or variable speed.

CORROSION RESISTANT FINISHES (E) for harsh or hazardous environments.

MANUAL OVERRIDES for winch operation in power loss situations.

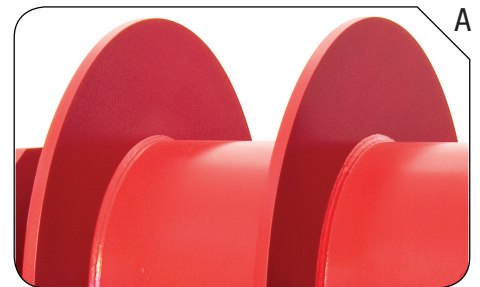

Shown with double compartment drum modification.

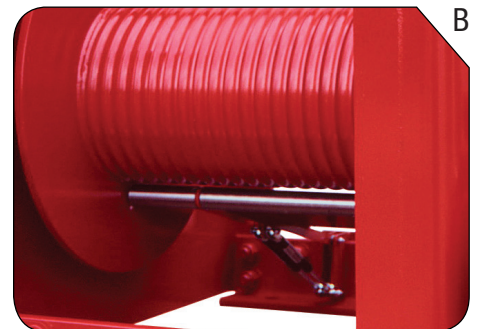

Shown with cable pressure bar and grooved drum modification.

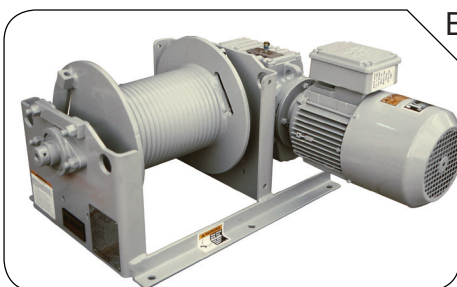

Shown with grooved drum modification and gray epoxy finish.

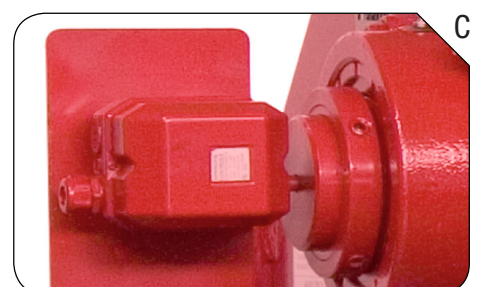

4HWF SERIES POWER WINCHES

4HWF Series Performance Characteristics

	Model Number Extensions			Motor hp	Load Rating						Line Speed			
	Load Rating (lb)	Line Speed (fpm)	Motor Codes ¹	hp	1st Layer		Mid Drum		Full Drum		1st Layer		Full Drum	
					(lb)	(kg)	(lb)	(kg)	(lb)	(kg)	(fpm)	(mpm)	(fpm)	(mpm)
4HWF1M	1500	25	D, E, F	1.5	1,500	681	900	409	700	318	23	7.0	52	15.8
4HWF1M	1500	35	D, E, F	2	1,500	681	900	409	700	318	32	9.8	73	22.3
4HWF2M	2000	25	D, E, F	2	2,200	998	1,500	681	1,200	545	22	6.7	40	12.2
4HWF2M	2000	35	D, E, F	3	2,200	998	1,500	681	1,200	545	34	10.4	63	19.2
4HWF4M	4000	25	D, E, F	3	4,000	1,815	2,500	1,134	1,800	817	21	6.4	47	14.3
4HWF4M	4000	35	D, E, F	5	4,000	1,815	2,500	1,134	1,800	817	35	10.7	78	23.8
4HWF6M	6000	25	D, E, F	5	6,000	2,722	4,400	1,996	3,400	1,543	24	7.3	42	12.8
4HWF6M	6000	35	D, E, F	7.5	6,000	2,722	4,400	1,996	3,400	1,543	35	10.7	61	18.6
4HWF8M	8000	25	D, E, F	7.5	8,100	3,675	5,800	2,631	4,500	2,042	27	8.2	47	14.3
4HWF8M	8000	35	D, E, F	10	8,100	3,675	5,800	2,631	4,500	2,042	39	11.9	64	19.5

Motor Codes		
D	230 volt	3 phase
E	460 volt	3 phase
F	All other voltages please contact factory	

Please contact factory or nearest Thern Distributor for firm fixed price and delivery.

4HWF Series Drum Capacities

Wire Rope Dia.		Breaking Strength ²		Drum Capacity	4HWF1M		4HWF2M		4HWF4M		4HWF6M		4HWF8M		
(in)	(mm)	(lb)	(kg)		(ft)	(m)	(ft)	(m)	(ft)	(m)	(ft)	(m)	(ft)	(m)	
1/4	6.4	7,000 ³	3,175	1st	43	13.1	51	15.5	-	-	-	-	-	-	
				Mid	370	112.8	340	103.6	-	-	-	-	-	-	-
				Full	830	253.0	750	228.6	-	-	-	-	-	-	-
5/16	7.9	9,800 ³	4,445	1st	34	10.4	41	12.5	87	26.5	-	-	-	-	
				Mid	250	76.2	230	70.1	950	289.6	-	-	-	-	-
				Full	560	170.7	500	152.4	2,120	646.2	-	-	-	-	-
3/8	9.7	15,100	6,849	1st	27	8.2	33	10.1	70	21.3	-	-	-	-	
				Mid	180	54.9	160	48.8	680	207.3	-	-	-	-	-
				Full	400	121.9	360	109.7	1,520	463.3	-	-	-	-	-
7/16	11.2	20,400	9,254	1st	23	7.0	28	8.5	60	18.3	76	23.2	-	-	
				Mid	130	39.6	120	36.6	510	155.4	450	137.2	-	-	-
				Full	300	91.4	270	82.3	1,140	347.5	990	301.8	-	-	-
1/2	12.7	26,600	12,066	1st	-	-	-	-	52	15.8	66	20.1	-	-	
				Mid	-	-	-	-	400	121.9	350	106.7	-	-	-
				Full	-	-	-	-	890	271.3	770	234.7	-	-	-
9/16	14.2	33,600	15,240	1st	-	-	-	-	46	14.0	58	17.7	89	27.1	
				Mid	-	-	-	-	320	97.5	280	85.3	540	164.6	
				Full	-	-	-	-	710	216.4	620	189.0	1,210	368.8	
5/8	16.0	41,200	18,688	1st	-	-	-	-	-	-	51	15.5	78	23.8	
				Mid	-	-	-	-	-	-	230	70.1	440	134.1	
				Full	-	-	-	-	-	-	510	155.4	990	301.8	
3/4	19.1	58,800	26,671	1st	-	-	-	-	-	-	42	12.8	65	19.8	
				Mid	-	-	-	-	-	-	160	48.8	310	94.5	
				Full	-	-	-	-	-	-	360	109.7	700	213.4	
7/8	22.4	79,600	36,106	1st	-	-	-	-	-	-	-	-	54	16.5	
				Mid	-	-	-	-	-	-	-	-	230	70.1	
				Full	-	-	-	-	-	-	-	-	500	152.4	
1	25.4	103,400	46,902	1st	-	-	-	-	-	-	-	-	47	14.3	
				Mid	-	-	-	-	-	-	-	-	180	54.9	
				Full	-	-	-	-	-	-	-	-	390	118.9	

² Values based on 6x37 IWRC EIPS wire rope.

³ Values based on 7x19 galvanized aircraft cable.

Actual drum capacities 25-30% less, due to nonuniform winding. Wire rope tension will also affect drum capacity.

Wire rope should be selected based on the breaking strength to load rating ratio and application parameters. Industry standards suggest a 5:1 breaking strength to load rating ratio for lifting and a 3:1 ratio for pulling.

Electric Motor Controls

	Description	Approx. Ship Wt.	
		(lb)	(kg)
10S3D4	electric motor controls 230/3/60 to 3 hp	25	12
10S7D4	electric motor controls 230/3/60 to 7.5 hp	25	12
10S10D4	electric motor controls 230/3/60 to 10 hp	28	13
10S7E4	electric motor controls 460/3/60 to 7.5 hp	25	12
10S15D4	electric motor controls 460/3/60 to 15 hp	25	12

Controls include NEMA 4 rated enclosure, and NEMA 4x rated pendant control on 50 foot cord.

Motor Controls sold separately.

Please contact factory or nearest Thern Distributor for firm fixed price and delivery.

All prices include mounting and wiring to motor.

IMPORTANT:

It is the owner's or operator's responsibility to determine the suitability of the equipment to its intended use. Study all applicable codes, manuals, and regulations. Be sure to read the Owner's Manual supplied with the equipment before operating it.

4HWF SERIES POWER WINCHES

4HWF Series

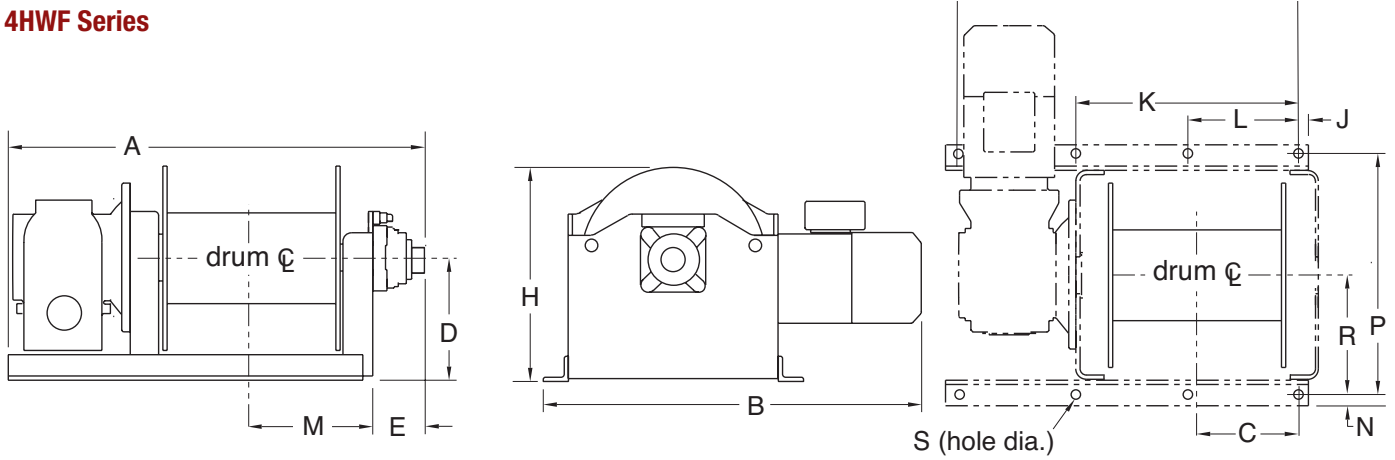

4HWF Series Winch Dimensions

	A		B		C		D		E		H		J		K	
	(in)	(mm)	(in)	(mm)	(in)	(mm)	(in)	(mm)	(in)	(mm)	(in)	(mm)	(in)	(mm)	(in)	(mm)
4HWF1M-1500-25	25.50	648	27.00	686	6.00	152	8.00	203	2.38	60	14.00	356	1.00	25	20.00	508
4HWF1M-1500-35	25.50	648	27.00	686	6.00	152	8.00	203	2.38	60	14.00	356	1.00	25	20.00	508
4HWF2M-2000-25	26.25	667	28.00	711	6.00	152	8.00	203	2.38	60	14.00	356	1.00	25	20.00	508
4HWF2M-2000-35	26.25	667	29.75	756	6.00	152	8.00	203	2.38	60	14.00	356	1.00	25	20.00	508
4HWF4M-4000-25	39.00	991	35.00	889	9.63	245	12.00	305	5.13	130	21.00	533	1.00	25	30.50	775
4HWF4M-4000-35	39.00	991	35.00	889	9.63	245	12.00	305	5.13	130	21.00	533	1.00	25	30.50	775
4HWF6M-6000-25	41.00	1,041	36.00	914	9.63	245	12.00	305	5.13	130	21.00	533	1.00	25	30.50	775
4HWF6M-6000-35	41.00	1,041	39.00	991	9.63	245	12.00	305	5.13	130	21.00	533	1.00	25	30.50	775
4HWF8M-8000-25	50.00	1,270	43.50	1,105	12.00	305	14.50	368	6.25	159	25.50	648	1.25	32	26.50	673
4HWF8M-8000-35	50.00	1,270	45.50	1,156	12.00	305	14.50	368	6.25	159	25.50	648	1.25	32	26.50	673

	L		M		N		P		R		S (Hole Dia.)		V		Ship. Wt.	
	(in)	(mm)	(in)	(mm)	(in)	(mm)	(in)	(mm)	(in)	(mm)	(in)	(mm)	(in)	(mm)	(lb)	(kg)
4HWF1M-1500-25	10.00	254	7.56	192	0.63	16	15.75	400	7.88	200	¹⁹ / ₃₂	15	-	-	190	87
4HWF1M-1500-35	10.00	254	7.56	192	0.63	16	15.75	400	7.88	200	¹⁹ / ₃₂	15	-	-	190	87
4HWF2M-2000-25	10.00	254	7.56	192	0.63	16	15.75	400	7.88	200	¹⁹ / ₃₂	15	-	-	240	109
4HWF2M-2000-35	10.00	254	7.56	192	0.63	16	15.75	400	7.88	200	¹⁹ / ₃₂	15	-	-	240	109
4HWF4M-4000-25	15.25	387	11.50	292	1.00	25	24.00	610	12.00	305	⁷ / ₈	22	-	-	480	218
4HWF4M-4000-35	15.25	387	11.50	292	1.00	25	24.00	610	12.00	305	⁷ / ₈	22	-	-	480	218
4HWF6M-6000-25	15.25	387	11.50	292	1.00	25	24.00	610	12.00	305	⁷ / ₈	22	-	-	650	295
4HWF6M-6000-35	15.25	387	11.50	292	1.00	25	24.00	610	12.00	305	⁷ / ₈	22	-	-	710	323
4HWF8M-8000-25	13.25	337	14.50	368	1.13	29	28.75	730	14.38	365	1 ⁻¹ / ₈	29	39.75	1,010	1,120	509
4HWF8M-8000-35	13.25	337	14.50	368	1.13	29	28.75	730	14.38	365	1 ⁻¹ / ₈	29	39.75	1,010	1,180	536

Dimensions are for reference only and subject to change without notice. Please contact factory for exact dimensions.

4HWF Series Drum Dimensions

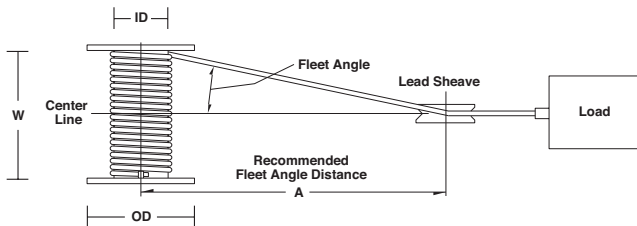

	Drum Diameter (ID)		Flange Diameter (OD)		Drum Width (W)		Fleet Angle Dist (A) ⁴	
	(in)	(mm)	(in)	(mm)	(in)	(mm)	(ft)	(m)
4HWF1M	4.50	114	12.00	305	10.00	254	16	4.9
4HWF2M	5.50	140	12.00	305	10.00	254	16	4.9
4HWF4M	7.00	178	18.00	457	16.00	406	26	7.9
4HWF6M	9.00	229	18.00	457	16.00	406	26	7.9
4HWF8M	10.75	273	22.00	559	20.00	508	32	9.8

⁴ Recommended minimum distance between drum and lead sheave for smooth drum.

Dimensions are for reference only and subject to change without notice. Please contact factory for exact dimensions.

TERN POWER WINCHES

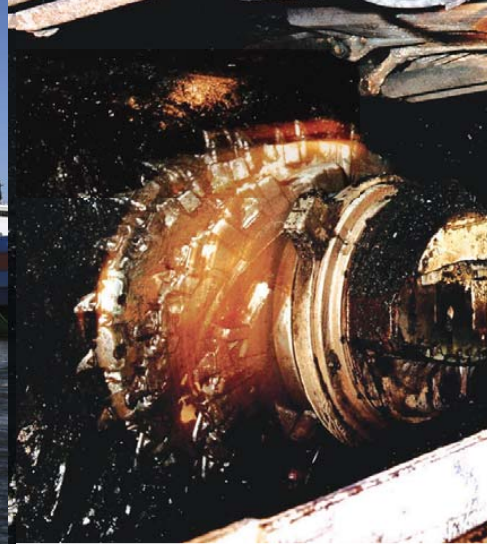

LIFT 50 TONS, WHAT DO YOU GET? SIMPLE, RESPECT

Mighty and reliable, Thern power winches can lift, hoist, pull or position up to 100,000 lb to handle any task you've got. Our broad range of standard models can be quickly adapted to suit custom applications. Plus our power winches feature top of the line gear reducers, rugged steel construction, load holding brake motors, and legendary performance and craftsmanship.



➤ **CUSTOMIZABLE**

We build to suit. Thern power winches come in a wide variety of base configurations, making it fast and affordable to customize a winch to your application.

➤ **DURABLE**

Thern's heavy duty power winches are built to take the around the clock punishment of hard working jobsites. Everything about them, from fabricated steel frame to industrial strength controls, says "no kid gloves" required.

➤ **EXPERIENCE**

Thern has the experienced people you rely on to get the right product for the job. Our unmatched know-how means you won't end up with a solution that only creates new problems.



Series 4WS



Series 4HS6-26M
Clutch model shown

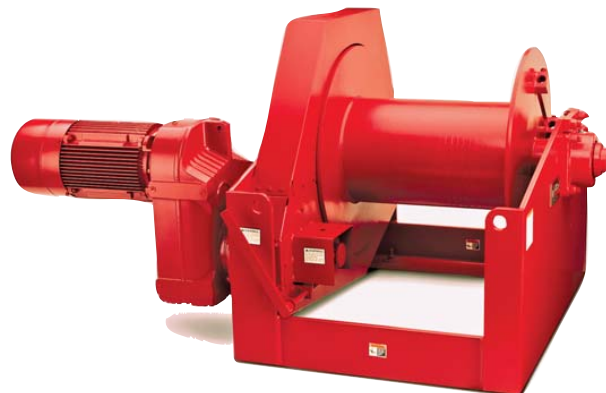

Series 4HS40-56M
Clutch model shown



TERN POWER WINCHES



ONE IF BY LAND, TERN IF BY SEA

Just because something floats, doesn't mean it isn't heavy. Try raising and lowering accommodation ladders, launching deep water research equipment or towing a vessel. It takes strength, control and stamina. It takes a Thern heavy duty power winch.

WHEN IT COMES TO HANDLING, THERE'S BULK AND THERE'S BULK

Thern power winches are used to pull trains, position barges, or lift behemoth conveyors. Why? They have the muscle and endurance to do it over the long haul without failure.

A MINER'S BEST FRIEND

Hard, heavy, dirty. That's everything you need to know about mining. Conditions are poor, mechanical strain constant, and loads a bear, but Thern power winches can handle any task you find in a mine.

POWERFUL ENOUGH FOR POWER PLANTS

Everything about a power plant is big – from steel doors to flare stacks, and it all needs to be lifted, lowered, or positioned. Durable and easily customized, Thern power winches help keep power plants running.



Series 4HWF

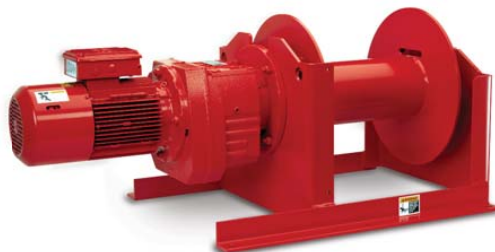

Series 4HPF



Series 4HPFC
Clutch model shown