

WARNING:

Before putting tool in service,
take to your immediate
supervisor.

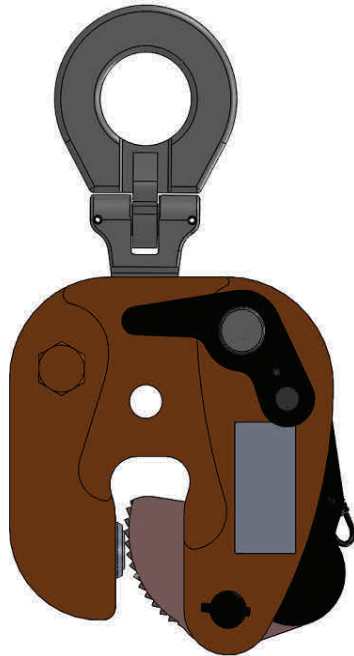

RENFROE



Model LPA

Model LPA Clamp
Application, Operation and Maintenance Manual

OM LPA 115



Operators Manual

This Operator's Manual covers the Application, Operation and Maintenance of this RENFROE product. Operator's Manuals for other current RENFROE products are available upon request. Direct requests to J.C. Renfro & Sons Jacksonville, Florida 32201.

J.C. RENFROE & SONS

of Jacksonville, Florida, has been an international leader in the manufacture and marketing of Lifting Clamps for over fifty years. **RENFROE** products are manufactured in Jacksonville, Florida. A worldwide network of stocking distributors provides a readily available source of supply and service.

J.C. RENFROE & SONS

Jacksonville, Florida 32201
Telephone: 904/356-4181
Toll Free: 1-800-874-8454
Fax: 904/354-7865
www.jcrenfroe.com

THIS PUBLICATION SUPERSEDES ALL PREVIOUSLY PUBLISHED AND/OR DISTRIBUTED INFORMATION BY MANUFACTURER AND/OR ITS DISTRIBUTORS WITH RESPECT TO APPLICABLE RENFROE PRODUCTS AND SUBJECT MATTER DESCRIBED OR CONTAINED HEREIN.

WARNING:

Prior to selection, operation and/or maintenance of RENFROE products, read and understand the information provided in this manual.

The understanding and use of the Definitions are important in determining the limitations and proper application of RENFROE products.

Failure to review and utilize recommended applications, operation and maintenance instructions may result in serious injury to operator and others.

NOTICE OF EXCLUSION OF WARRANTY

RENFROE HAS HEREIN SET FORTH IN CONSPICUOUS LANGUAGE AN EXCLUSION OF ANY WARRANTY EITHER EXPRESSED OR IMPLIED, WHICH IS NOT SPECIFICALLY AND PARTICULARLY CONTAINED HEREIN. PLEASE REFER TO THAT STATEMENT FOR REPRESENTATIONS AND WARRANTIES OF PRODUCTS MANUFACTURED BY J.C. RENFROE & SONS

OPERATING AIDS

(DO'S AND DON'TS)

1. **DO** read and understand the operator's manual before using clamp.
2. **DO** consult Operators Manual or RENFROE when in doubt.
3. **DON'T** lift over workmen. **DON'T** lift over safety areas or personnel.
4. **DO** attend a factory training class for establishing proper use of Renfro Products.
5. **DO** Lock clamp closed when clamps are fitted with a lock. **DON'T** lift with lock in open or "lock open" position.
6. **DON'T** use a connection that may release the clamp.
7. **DON'T** attach clamp directly to crane hook. **DO** use a flexible connection between crane hook and clamp shackle. **DON'T** use heavy flexible connection.
8. **DO** use correct clamp for job. **DON'T** use large capacity clamps to lift light loads.
9. **DO** use an adequate number of clamps to balance load. **DON'T** lift loads that are not balanced.
10. **DO** use clamps within their rated capacity. **DON'T** overload clamps.
11. **DO** inspect clamp before each lift, follow inspection and maintenance instructions outlined in the manual and use RENFROE replacement parts to assure proper operation of the clamp.
12. **DON'T** use clamp that has been overloaded. **DO** refer to pre-lift inspection in Operator's Manual.
13. **DON'T** side load with a straight shackle clamp.
14. **DON'T** misuse. **DON'T** lift plate from bottom of plate stack.
15. **DON'T** rush. **DON'T** lift more than one plate at a time with a vertical clamp.
16. **DON'T** improvise. Always use correct clamp for the job. **DON'T** lift plate horizontally with a vertical lift only clamp.
17. **DON'T** alter clamp. **DON'T** grind, weld or modify the clamp in any manner.

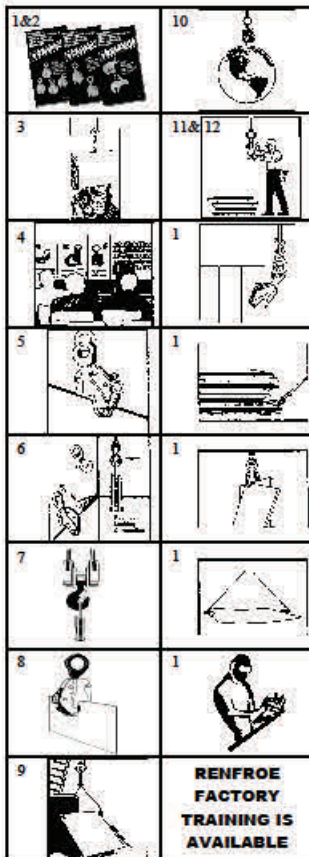

J.C. RENFROE & SONS
EMPLOYEE OWNED

1926 SPEARING STREET / JACKSONVILLE, FL. 32206

Phone: 904-356-4181
Facsimile: 904-354-7865
Internet: www.jrenfro.com
E-Mail: sales@jrenfro.com

OPERATING AIDS (DO'S AND DON'TS)

1. DO read and understand the Operators Manual before using the clamp
2. DO Consult Operator's Manual or RENFROE when in doubt.
3. DON'T Lift over workmen DON'T lift over Safety Areas or personnel.
4. Do attend a factory training class for establishing proper use of Renfroe Products.
5. DO Lock clamp closed before lifting load. DON'T lift with lock in open or "Lock Open" position.
6. DON'T Use a connection that may release the clamp.
7. DON'T attach clamp directly to crane hook. DO use a flexible connection between crane and clamp shackle. DON'T use heavy flexible connection.
8. DO use correct clamp for job. DON'T use large capacity clamps to lift light loads.
9. DO Use an adequate number of clamps to balance load. DON'T lift loads that are not balanced.
10. DO Use clamps within their rated capacity. DON'T overload clamps
11. DO Inspect clamp before each lift, follow inspection and maintenance instructions outlined in this manual and use RENFROE replacement parts to assure proper operation of the clamp
12. DON'T Use clamp that has been overloaded. DO refer to pre-lift inspection in Operators Manual
13. DON'T Side load with a straight shackle clamp. DON'T lift from side with vertical clamp
14. DON'T Misuse. DON'T lift plate from bottom of plate stack.
15. DON'T Rush. DON'T lift more than one plate at a time with a vertical clamp.
16. DON'T Improvise. Always use correct clamp for job. DON'T lift plate horizontally with a vertical lift only clamp.
17. DON'T Alter clamp. DON'T grind, weld or modify the clamp in any manner.

DEFINITIONS

VERTICAL LIFT: The lifting of a single plate or member in which the lifting force exerted by the rigging is directly above and in line with the lifting shackle as shown in the illustration below.

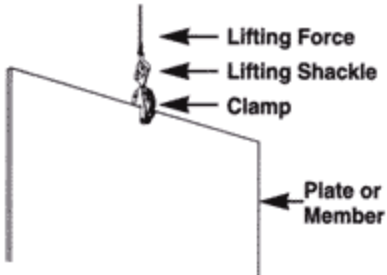

VERTICAL TURN/LIFT: A vertical turn/lift clamp is a vertical lifting clamp specifically intended to turn a single plate or member thru a ninety degree (90°) arc and back to vertical thru the same ninety degree (90°) arc or from horizontal to vertical to horizontal thru a one hundred and eighty degree (180°) arc. Refer to Application Section of specific Turn/Lift clamps for further detail. During the turning operation the edge of the plate opposite the edge to which the clamp is attached should always be in contact with a supporting surface such as a factory floor and the load on the clamp not exceed one half rated capacity of clamp—refer to illustrations shown below.

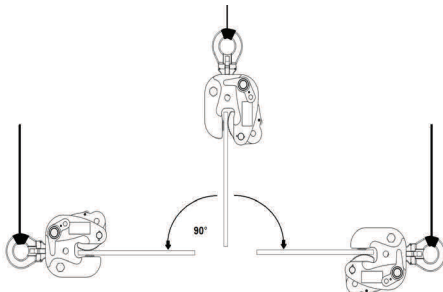

STEEL PLATES: Unless otherwise specified, lifting clamps are manufactured to handle hot-rolled steel plates whose Brinell Hardness does not exceed 300.

WARNING: Do not lift plates with coatings or mill scale that prevent the gripping surfaces of the clamp from making positive contact with the base metal.

For applications not covered by the above information, secure written recommendations from RENFROE.

FINISHED AND POLISHED PLATES: Steel plates in this category have other than hot-rolled surfaces such as stainless steel, etc., are generally handled using non-marring clamps incorporating smooth gripping surfaces.

STRUCTURAL MEMBERS—FABRICATED SECTIONS: Unless otherwise specified, clamps described as capable of handling structural members and fabricated sections are limited to hot-rolled steel whose Brinell Hardness does not exceed 300.

WARNING: For applications not covered by the above information, secure written recommendations from RENFROE.

RATED CAPACITY: The rated capacity of a RENFROE product is based on the product being in “new or as new” condition and represents the maximum load the product is to be subjected to when utilized in the manner described in this manual. Wear, misuse, abuse and other factors relating to usage may reduce the rated capacity. Shock loading and the factors listed must be taken into consideration when selecting a RENFROE product for a given application.

PLATE THICKNESS: The minimum and maximum plate thickness a clamp specified for handling plates is capable of lifting.

WARNING: Never use a clamp for lifting a plate where the plate thickness is less than or greater than the minimum and maximum stenciled on the clamp.

JAW OPENING: The minimum and maximum thickness of a member of clamp specified as having a JAW OPENING is capable of handling

WARNING: Never use a clamp on a member whose thickness is less than or greater than the range of jaw opening stenciled on the clamp.

OPERATING TEMPERATURES: Unless specified under the Application Section of the individual model, the approved operating temperature of RENFROE clamps is from zero degrees Fahrenheit (-18 Celsius) to a maximum of 200 degrees Fahrenheit (+93 degrees Celsius). The minimum and maximum temperatures apply to both ambient and the material being handled by the clamp.

WARNING: Secure written authorization from RENFROE before using clamps in temperatures other than shown.

“LOCK OPEN-LOCK CLOSED” - an over-center spring loaded mechanism in which the spring exerts a force on the gripping cam when the lock handle is moved to the “Lock Closed” position. When the handle is moved to the “Lock Open” the gripping cam is maintained in the retracted position for ease in installing the clamp on a plate or member. Refer to the Operation Section of specific models of the “Lock Open-Lock Closed” clamps for additional details. Typical “Lock Open-Lock Closed” clamps are Models FRD, R, S, SD, SEA, TL, TLA and the L-Series.

WARNING: A pointing out and notice of danger. The purpose of a “WARNING” is to apprise the operator and all other affected persons of the existence of danger of which he should be but may not be aware and to enable the operator to protect himself and others where applicable against such danger. An attempt is made herein to warn against reasonable and reasonably foreseeable danger in the proper use and possible reasonable misuse of RENFROE products described in this manual.

DESIGNATED PERSON — A person selected by the employer or the employer's representative as being competent to perform those specific duties.

QUALIFIED PERSON — A person who, by possession of a recognized degree in an applicable field or certificate of professional standing, or who, by extensive knowledge, training, and experience, has successfully demonstrated the ability to solve problems relating to the subject matter at hand.

Model LPA

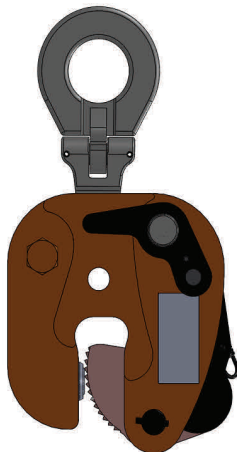

Application LPA

The model LPA has a lock open and lock closed feature built into its design. The LPA has an auxiliary lock. The LPA clamp is recommended for turning of a single steel plate from horizontal to vertical to horizontal through a hundred and eighty degree arc. Refer to Illustration A. The Auxiliary lock prevents the lock handle from moving from the “Lock Closed” position until the auxiliary lock button is manually depressed. The “Lock Open” “Lock Closed” feature facilitate attaching and removing the clamp from the plate. Refer to Definition Pages for explanation of “Lock Open” “Lock Closed” clamp. A pivoting shackle is included on the LPA clamp.

Refer to Illustration B.

WARNING: Refer to Load Chart showing de-rating of rated capacity based on angle of side loading.

For identification of component parts, refer to exploded view of clamp located at the end of the Maintenance Section.

WARNING: When turning a plate from horizontal to vertical, the operator must position the clamp at the start of the turning operation so that the lock handle is on the topside of the plate when the plate is in the horizontal position. It should be noted at the finish of a 180 degree turn that the lock handle will be on the underside of the plate and therefore sufficient clearance under the plate should be allowed for the lock to be disengaged. Refer to the sections on Operation and Maintenance for the approved procedures in the Operation and Maintenance of this product.

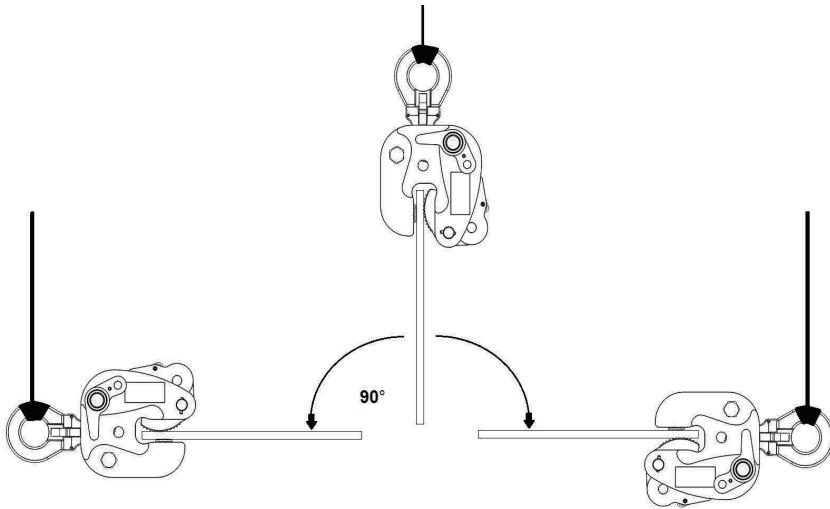

Illustration A

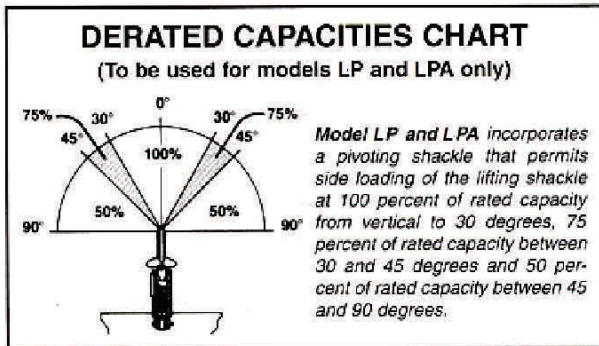

Illustration B

OPERATION LPA

Step 1.

Before using any RENFROE clamp, refer to the Application Section to confirm that the operation to be undertaken is an appropriate application for this product.

Step 2.

Select appropriate capacity and plate thickness. The model designation, capacity and plate thickness are stenciled on each clamp.

WARNING: Never exceed rated capacity or use on plates that are not within the range of plate thickness stenciled on the clamp. Lift only one plate on each lift.

Always use a clamp with maximum plate thickness and rated capacity near equal to the thickness and weight of the plate being lifted.

Step 3.

Inspect clamp before each lift.

WARNING: Do not use if in need of repair.

- A. Check the clamp to be certain the identification and warning tags are present and legible.
- B. Do not use the clamp if the tags are missing or illegible.
- C. Inspect gripping surfaces for wear and defects. Gripping surfaces must be sharp and free of foreign matter.
- D. Inspect condition of body for wear, damage and distortion, particularly in the area of the jaw opening.
- E. Inspect lifting shackle and all pins for wear and damage.
- F. Lock spring must have definite amount of tension when the lock is moved to the "Lock Closed" position without material in the clamp. Lock Pawl must rest on body spacer sleeve.
- G. On the model LPA the auxiliary lock button must have a positive spring action that projects it out to engage the lock handle when the handle is moved to the "Lock Closed" position.
- H. Remove from service any clamp in need of repair.

AUXILIARY LOCK

The Auxiliary Lock Release Button is mounted in the Lock Handle. When Lock Handle is in “Lock Closed” position the Auxiliary Lock Release Button is flush with the top of the Lock Handle.

WARNING: Do not use clamp unless auxiliary lock is fully engaged and auxiliary push button is flush with top of lock handle.

The Lock Button for the Auxiliary Lock is spring loaded and is mounted in the clamp body.

WARNING: Do not use clamp unless lock button spring extends button to fully engage auxiliary release button when lock handle is in “Lock Closed” position.

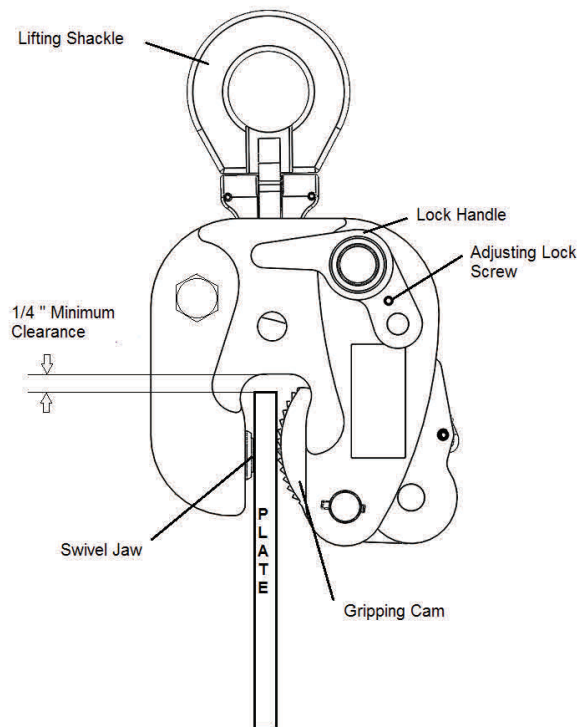

Illustration C

Step 4.

The clamp is a component of the rigging used in lifting or transporting a plate. It is important to use safe and adequate rigging. The lock is used to hold the clamp in place until the gripping mechanism is actuated by a force applied to the lifting shackle.

WARNING: Improper or excessively heavy rigging may interfere with the operation of the clamp and its ability to maintain a proper position on the plate. Never attach crane hook directly to the clamp—always use a flexible sling between crane hook and clamp.

Step 5.

Move the lock lever to the “Lock Open” position. Gripping cam is maintained in retracted position. Refer to illustrations C and D.

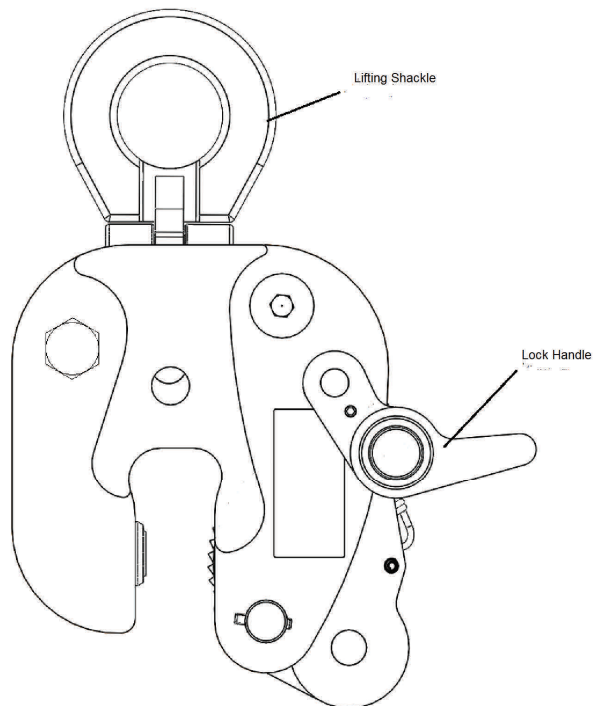

Illustration D

Step 6.

Position clamp on plate being lifted.

Do not allow inside of jaw opening to rest on edge of plate. Maintain 1/4" clearance. Refer to Illustration C and D, Step 5.

Position clamp so direction of force applied by the crane is the capability of the lifting shackle. Model LPA refer to De-rated Capacities Chart.

Step 7.

Make certain the gripping surfaces of the clamp are fully in contact with the plate, and not partially on and off the edge of the plate.

Step 8.

Place the lock lever in the "Lock Closed" position. Lock Pawl must rest on body spacer sleeve. Spring now exerts force on gripping cam. On model LPA make certain the auxiliary lock button projects from the housing and fully engages the lock handle. Refer to Illustration M

WARNING: Lift only when clamp is in "Lock Closed" position.

Step 9.

Commence lift.

WARNING: The operator should position himself away from the fully clear of the member to be lifted. Plates being turned have a tendency to slide. Do not commence lift until all personnel are clear of the area of the lift. Never stand under or near a member being lifted, lowered or moved.

Refer to Photograph L.

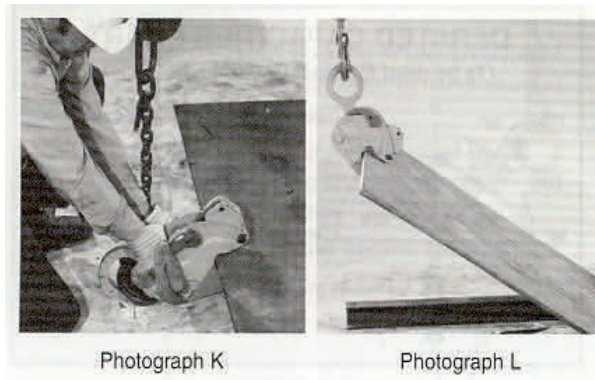

Step 10.

To remove clamp: after plate is fully supported and at rest in a stable position, relax lifting force, keeping hands clear (depress auxiliary lock button on LPA) move lock handle to “Lock Open” position. Lift clamp from plate. Refer to Illustrations C and D, Step 5.

Step 11.

Inspect clamp. Remove from service if in need of repair.

WARNING: In the event the stenciling is worn and not legible or the tag containing the model, capacity and other pertinent information is missing—do not use clamp until it has been properly labeled. Renfroe will replace tag at no charge upon request.

Inspection kits are available at no charge upon request from the distributor or RENFROE.

Kit contains:



Maintenance Program for Renfroe Clamps Manufactured from Steel

The severity of service to which the clamp is subjected in the work place determines the frequency and type of inspection procedure required for the clamp. The frequency and type of inspection is determined by the clamp owner. Renfroe acknowledges the ASME B30.20 safety standard which sets forth minimum inspection requirements for "Below-the-Hook" lifting devices and the Renfroe Recommended Inspection Schedule meets and/or exceeds the ASME inspection recommendations.

Before using a clamp operators should be trained by a qualified person to visually inspect a lifting clamp that will include but not be limited to the following:

Every lift Inspection:

A visual inspection by the operator before and after each lift made by the clamp.

- A. Check the clamp to be certain the identification and warning tags are present and legible.
- B. Do not use the clamp if the tags are missing or illegible.
- C. Inspect gripping surfaces for wear and defects. Gripping surfaces must be sharp and free of foreign matter.
- D. Inspect condition of body for wear, damage and distortion, particularly in the area of the jaw opening.
- E. Inspect lifting shackle and all pins for wear and damage.
- F. Lock spring must have definite amount of tension when the lock is moved to the "Lock Closed" position without material in the clamp. Lock pawl must rest on body spacer sleeve.
- G. On the model IPA the auxiliary lock button must have a positive spring action that projects it out to engage the lock handle when the handle is moved to the "Lock Closed" position.
- H. Remove from service any clamp in need of repair.

WARNING: Do not use the clamp if in need of repair.

If, during the every lift inspection, the operator believes the clamp exhibits excessively worn parts or is damaged, the clamp should be inspected by a qualified person who will make a determination as to its fitness to make a lift. At this time the condition of the clamp should be noted and recorded. After inspection by the qualified person it may be decided that a periodic inspection procedure is necessary.

Frequent Inspection:

A visual inspection (see every lift inspection) by an operator or other designated person timed according to the clamp's service class.

- **Normal Service:** monthly
- **Heavy Service:** weekly to monthly
- **Severe Service:** daily to weekly.

If, during the frequent inspection, the operator or designated person believes the clamp exhibits excessively worn parts or is damaged the clamp should be inspected by a qualified person who will make a determination as to its fitness to make a lift. At this time the condition of the clamp should be noted and recorded. After inspection by the qualified person it may be decided that a periodic inspection procedure is necessary.

Periodic Inspection:

A recorded inspection by a qualified person as described in the Periodic Inspection Procedure below timed according to the clamps service class.

- **Normal Service:** annual
- **Heavy Service:** semi-annual
- **Severe Service:** quarterly.

If during any inspection a condition is found which leads to a periodic inspection then the next periodic inspection is due from the time the clamp is returned to service. See the table below.

Normal Service-One Year
Heavy Service-6 Months
Severe Service-3 Months

Warning: If any hazardous condition is found that may cause injury to the operator or other personnel then the clamp should be subjected to a Periodic Inspection by a Qualified Person.

Repair (replacement of worn parts)

During regular maintenance when replacing parts that are worn a record should be made of the parts replaced. After the replacement of worn parts clamps need not be load tested.

Repair (replacement of damaged parts)

During a repair in which parts are replaced due to damage a record should be made of the repair. At this time the clamp should be marked with the following information as per the ASME B30.20 requirements:

- **Name and address of the repairer**
- **Repairer's unit identification**
- **Clamp weight (if altered)**
- **Rated load (if altered)**
- **ASME BTH-1 Design Category (if altered)**
- **ASME BTH-1 Service Class (if altered)**

Model LPA Periodic Inspection Procedures

Step 1. Verify the identity of the clamp by checking the I.D. plate on the clamp body. If the I.D. plate is missing or not legible an RFID chip (Radio Frequency Identification Device) is embedded in the clamp body or a clamp component. If the I.D. plate is missing and the RFID chip is unavailable call the Renfro factory for instructions on returning the clamp for recertification. Refer to Exploded View for parts break down.

Step 2.
Completely disassemble clamp.

Step 3. Remove all dirt, grease and other matter that may inhibit proper inspection of the clamp body or clamp components.

BODY

- A. Inspect welds for fractures. RENFROE recommends a dye penetrant or similar method of detecting indications on the clamp. If an indication is found it may be necessary to use a magnetic particle, ultrasonic or similar methods for determining damage to the clamp or components. Inspect all pin holes for wear and elongation.
- B. Inspect inside jaw opening for displaced metal and distortion.
- C. Inspect clearance of lock handle assembly mounting hole for wear. Clearance with shaft of lock handle assembly should be minor. Mounting holes that are worn, oversized may cause the lock handle to malfunction. Refer to exploded view.

WARNING: Replace clamps containing fractures, elongated pin holes, worn or elongated swivel jaw center block hole, distorted jaw openings, clamp bodies with worn and/or rough shackle pin guide slots and/or a jaw opening with displaced metal.

Step 4.
LIFTING SHACKLE LPA-1

- A. Inspect lifting shackle eye for elongation and wear at point where eye engages sling attachment.
- B. Inspect shackle pin hole for wear and elongation.
- C. Inspect shackle body for bending.
- D. Inspect shackle pivot pin, mounting holes and retaining spiral pins. Elongated shackle eye indicates overloading. Elongated shackle pin holes indicate wear and possible overloading. Bent shackles indicate excessive side-loading.

WARNING: Replace shackles that are bent, show excessive wear at eye, or have elongated eye and/or shackle pin hole.

Step 5.

CAM ASSEMBLY LPA-5

- A. Inspect cam for chipped or worn teeth. Teeth must be sharp and free of foreign matter.
- B. Inspect cam straps for distortion and fractures.
- C. Inspect pin holes in cam straps and cam for elongation and wear.

WARNING: Replace cam assemblies that have cams with worn or damaged teeth and contain fractures, and cams and cam straps with elongated pin holes.

Step 6.

SHACKLE PIN - LPA-3 and CAM PIN - LPA-6

Inspect all pins for:

- 1. Distortion
- 2. Surface blemishes
- 3. Wear
- 4. Fractures

WARNING: Replace pins that are distorted, have surface scars and worn or contain fractures.

Step 7.

SWIVEL JAW LPA-8

- A. Inspect swivel jaw for fractures, damage, and wear. Serrations must be sharp and free of imperfections and foreign matter.
- B. Swivel jaw must turn freely in clamp. During assembly - insert lubricant in body recess before installing swivel jaw. Recommended lubricant is powdered graphite or Molybdenum Disulfide grease. Make certain spiral pins are in place.

Warning: Replace worn, dull or damaged swivel jaw.

Step 8.

SWIVEL JAW CENTER BLOCK LPA-10

- A. Inspect mounting hole in Center Block for elongation and wear.

Step 9.

BODY BOLT and BODY SPACER SLEEVE LPA-15

- A. Inspect body spacer sleeve at position where sleeve contacts shackle.
- B. Inspect body bolt and sleeve. When replacing bolt, tighten bolt and nut, at joint of thread to lock nut in place.

WARNING: Replace body bolt, nut and sleeve if worn or damaged.

Step 10.

AUXILIARY LOCK HOUSING and SLEEVE LPA-14

- A. Inspect sleeve for wear at position where sleeve contacts shackle. Replace if worn.
- B. Inspect auxiliary lock housing for distortion and wear.
- C. Inspect auxiliary lock button. The button must move in and out of housing without binding. The spring must be capable of maintaining button in extended position.

WARNING: Replace the auxiliary lock if damaged or the auxiliary lock button spring does not maintain the button in the extended position.

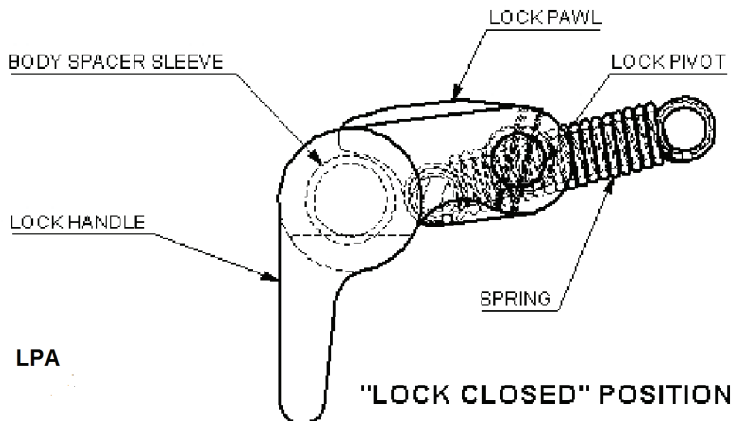

Illustration M

Step 11.

LOCK SPRING LPA-7

- A. Inspect lock spring for distortion. Spring must have a definite amount of tension when moved to the "Lock Closed" position without material in the clamp. Lock pawl must rest on body spacer sleeve. Refer to Illustration M.

Step 12.

LOCK ASSEMBLY LPA-13

- A. Inspect for damage and wear, particularly in the area where the lock handle engages the auxiliary lock's locking button.
- B. Inspect lock handle for binding, particularly when moving lock handle to the "Lock Closed" position. If binding does occur, adjust set screw in body of lock handle to provide adequate clearance. Refer to Illustration M, Step 11.
- C. Inspect lock assembly pivot shaft for wear. Shaft must have "Slip Fit" with lock handle pivot hole. Refer to exploded view.

WARNING: Replace lock assemblies that have worn or damaged parts, fit loosely in the body mounting hole and do not have a definite "Over Center" "Lock Closed" position. Replace worn and damaged bearings if supplied on clamp.

Step 13.

ASSEMBLY

After reassembly, check operation of clamp. All parts should move freely without binding. Refer to exploded view for proper location of component parts.

WARNING: All retaining pins and fasteners must be in place, including cam jaw washers where required.

GENERAL

RENFROE products may be returned to the factory for inspection and refurbishment in accordance with an established fee schedule.

Use only RENFROE replacement parts. Refer to RENFROE catalog for instructions on ordering replacement parts.

WARNING: Do not weld, grind or modify the clamp body or component parts in any manner. In the event the stenciling is worn and not legible or the tag containing the model, capacity, or other pertinent information is missing—do not use clamp until it has been properly labeled. Renfro will replace tag at no charge upon request.

EXCLUSION OF WARRANTY

THERE EXISTS NO WARRANTIES NEITHER EXPRESSED NOR IMPLIED WHICH EXTEND BEYOND THE DESCRIPTIONS OR STATEMENTS CONTAINED IN THE FACE OR ANY PART HEREOF.



J.C. RENFROE & SONS

P.O. Box 4279 • 1926 Spearing Street • Jacksonville, Florida 32206
Phone: U.S.A. Toll Free (800) 874-8454 (in Florida 904/356-4181)
Facsimile: 904/354-7865 • Internet: www.jcrenfroe.com