



ABELL-HOWE

J906 Wall Bracket Jib Crane

Installation, Operations, & Maintenance Manual



800.548.2930 | www.AbellHowe.com

INSTALLATION, OPERATION, & MAINTENANCE MANUAL

INTRODUCTION

Thank you for choosing an Abell-Howe Jib Crane. Your new crane was engineered and manufactured in Eureka, IL by Crane Equipment & Service, Inc., a world leader in lifting devices. This manual is primarily intended for the person responsible for the maintenance and operation of the crane. It will supply necessary safety, parts and service information providing you the best experience with your new crane. Also, it will help to give clear and explicit information for spare and renewal parts. This avoids misunderstandings, errors, unnecessary correspondence and delays in delivery.

IMPORTANT

It is important that the Serial No. for this crane is supplied whenever repair parts are required. For your convenience please fill in the Serial No. in the space provided below. The Serial No. may be found on the capacity decal.

JIB CRANE SERIAL NO: _____

CAPACITY: _____ **MODEL NO:** _____

LOCATION: _____ **PURCHASE DATE:** _____

PLEASE NOTE

Abell-Howe jib crane safety procedures are on pages 10-17.

Abell-Howe Jib Cranes are Engineered & Manufactured in Eureka, IL by Crane Equipment & Service, Inc.

800.548.2930 | www.AbellHowe.com



TABLE OF CONTENTS

PAGE 3	-	Installation Instructions: J906 Wall Bracket Type Jib Cranes (Welded Assembly)
PAGE 4	-	Installation Instructions: J906 Wall Bracket Type Jib Cranes (Bolted Assembly)
PAGE 5	-	Installation Drawing: J906 Welded Assembly General Arrangement
PAGE 6	-	Installation Drawing: J906 Bolted Assembly General Arrangement
PAGE 7	-	Lubrication & Maintenance Instructions
PAGE 7	-	Structural Bolt Torque
PAGE 8	-	Tagline Assembly
PAGE 9	-	Limit Rotation Stop
PAGE 10	-	Replacement Parts: J906 Wall Bracket Jib
PAGE 11	-	Safe Operating Procedures
PAGE 12	-	Inspection & Maintenance
PAGE 13	-	Inspection & Maintenance (Continued)
PAGE 14	-	Safe Operating
PAGE 15	-	Safe Operating (Continued)
PAGE 16	-	Safe Operating (Continued)
PAGE 17	-	Safe Operating (Continued) – Figure 1: Hand Signals
PAGE 18	-	Jib Crane Safety Do's & Don'ts



ABELL-HOWE CRANES.
 DIVISION OF CRANE, EQUIPMENT & SERVICE, INC.
 UNIT 100, 10321 WERCH DRIVE, WOODRIDGE IL 60517

INSTALLATION INSTRUCTIONS FOR J906-FCT WALL BRACKET TYPE JIB
 CRANES (WELDED ASSEMBLY)

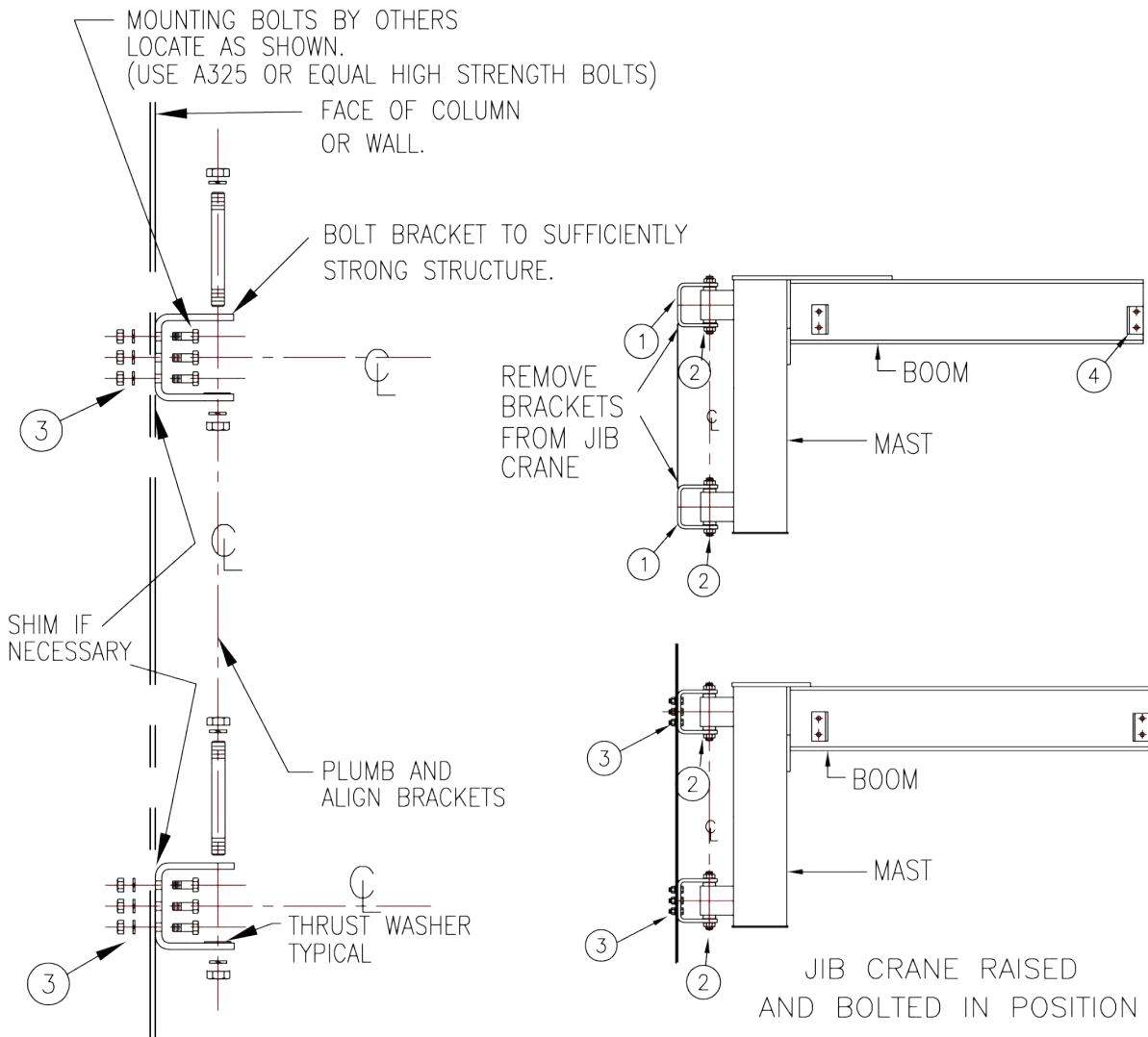

INSTRUCTIONS

1. REMOVE BRACKETS ① AND PIVOT PINS ② FROM JIB CRANE.
2. BOLT BRACKETS ① TO STRUCTURALLY ADEQUATE WALL OR COLUMN USING ③ A325 OR EQUAL HIGH STRENGTH BOLTS (BY OTHERS). MAKE SURE BRACKETS ARE IN LINE AND PLUMB THROUGH HOLES FOR PIVOT PINS ②.
3. RAISE JIB CRANE INTO POSITION AND ATTACH TO WALL BRACKETS ① USING PIVOT PINS ②.
4. REMOVE TROLLEY END STOPS ④, ADD HOIST/TROLLEY UNIT AND REPLACE TROLLEY END STOPS ④.



ABELL-HOWE CRANES.
 DIVISION OF CRANE, EQUIPMENT & SERVICE, INC.
 UNIT 100, 10321 WERCH DRIVE, WOODRIDGE IL 60517

INSTALLATION INSTRUCTIONS FOR J906-FCT WALL BRACKET TYPE JIB CRANES (BOLTED ASSEMBLY)

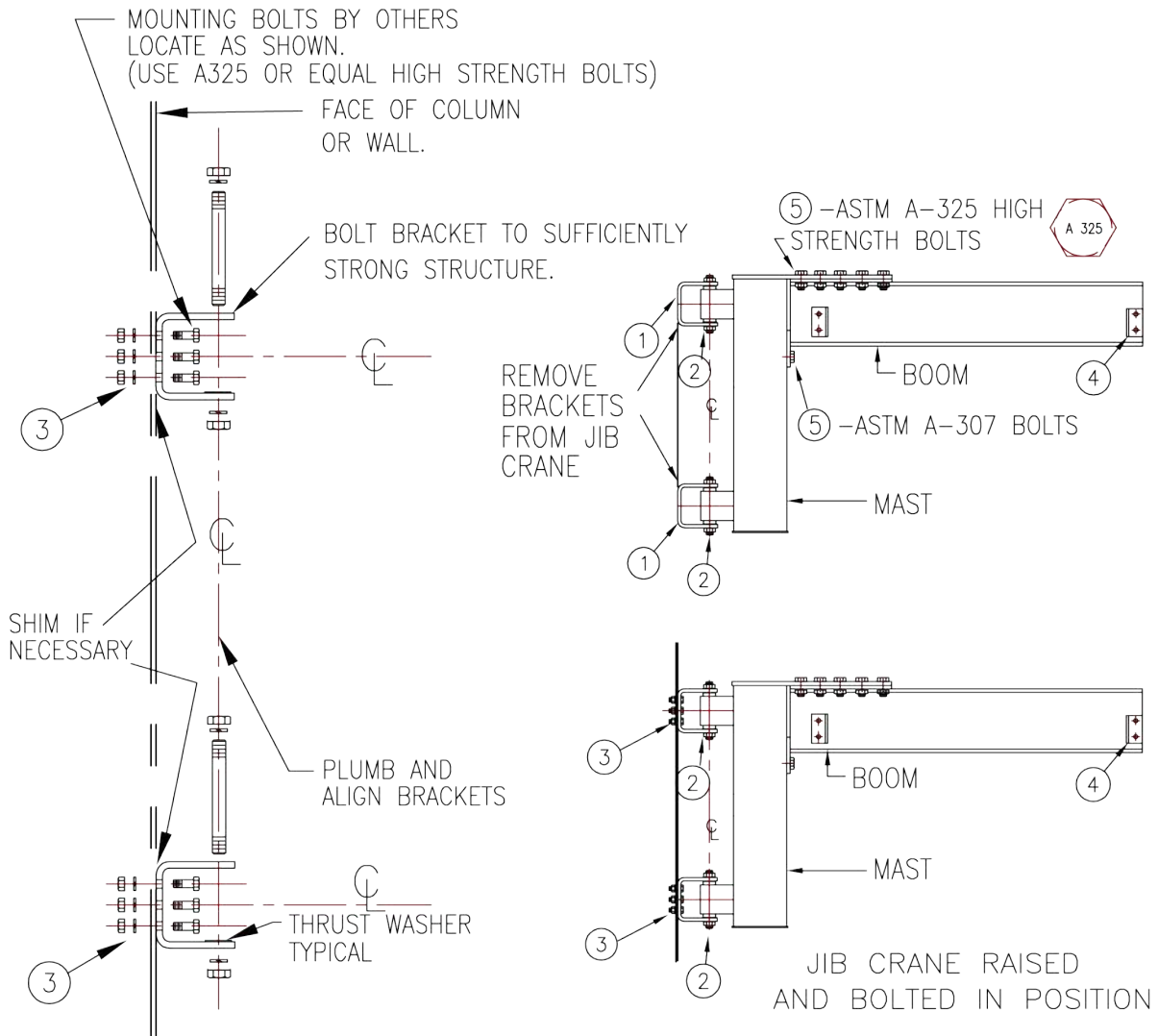

INSTRUCTIONS

1. JIB CRANE IS SHIPPED IN TWO PIECES, MAST AND BOOM. BOLT BOOM TO MAST WITH BOLTS ⑤ SUPPLIED. BY ABELL-HOWE CO.
2. REMOVE BRACKETS ① AND PIVOT PINS ② FROM JIB CRANE.
3. BOLT BRACKETS ① TO STRUCTURALLY ADEQUATE WALL OR COLUMN USING ③ A325 OR EQUAL HIGH STRENGTH BOLTS (BY OTHERS). MAKE SURE BRACKETS ARE IN LINE AND PLUMB THROUGH HOLES FOR PIVOT PINS ②.
4. RAISE JIB CRANE INTO POSITION AND ATTACH TO WALL BRACKETS ① USING PIVOT PINS ②.
5. REMOVE TROLLEY END STOPS ④, ADD HOIST/TROLLEY UNIT AND REPLACE TROLLEY END STOPS ④.

HOLES DIA. "Z"(FOR A325 OR EQUAL MOUNTING BOLTS)

NOTE: FOR INSTALLATION INSTRUCTIONS REFER TO BULLETIN I.I. J-906-1.

ABELL-HOWE CRANES, ASSUMES NO RESPONSIBILITY FOR LOADING IMPOSED ON BUILDING STRUCTURE BY THIS EQUIPMENT. WE SUGGEST THIS BE CHECKED BY A LICENSED STRUCTURAL ENGINEER AND ANY NECESSARY PERMITS BE SECURED.

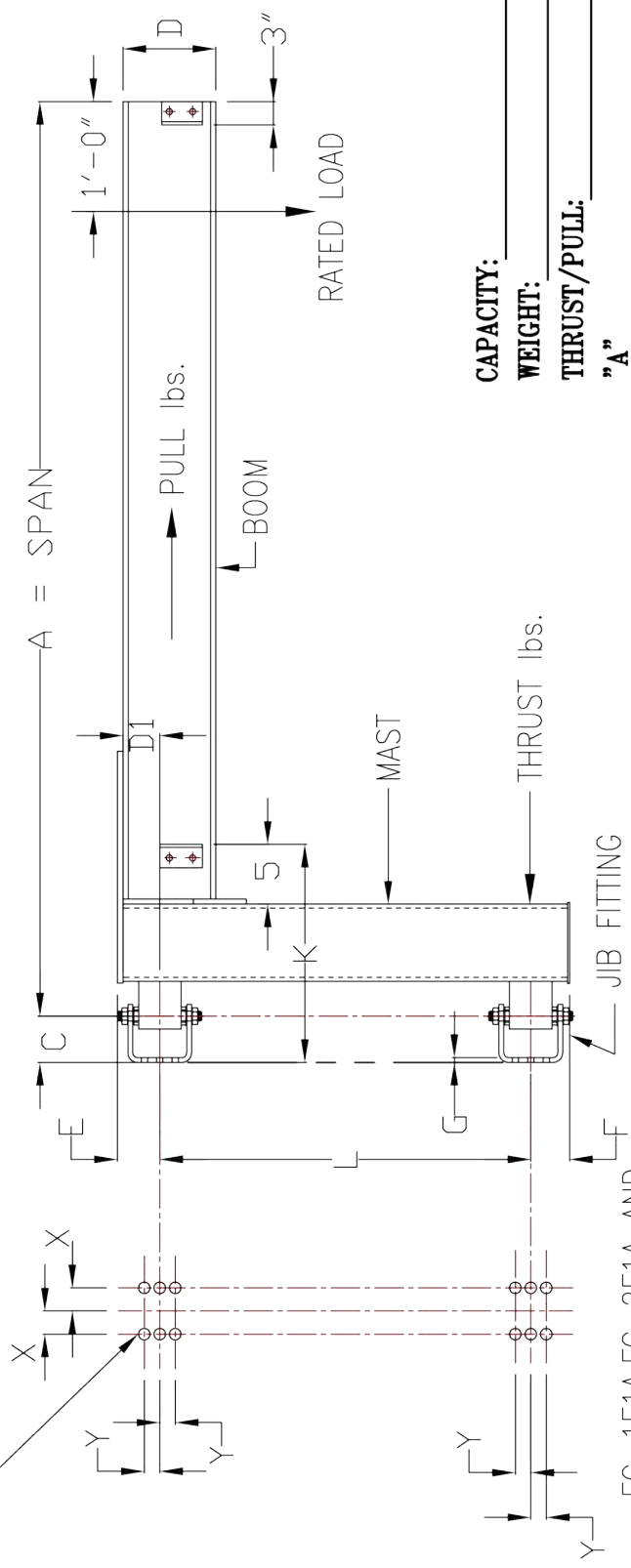

FC-1F1A, FC-2F1A AND FC-3F1A MOUNTING BOLT PATTERN

CAPACITY: _____
 WEIGHT: _____
 THRUST/PULL: _____
 "A" _____
 "L" _____
 CUSTOMER ORDER #: _____

CUSTOMER NAME: _____
 ABELL-HOWE CO#:

MODEL NO. J-906-FCT- _____
 WORK ORDER No. _____

MODEL NO.	J-906-FCT-1F1A-D			J-906-FCT-2F1A-D			J-906-FCT-3F1A-D			
BEAM	W6	W8	W10	W12	W16	W18	W21	W16	W18	W18
D	6 1/4"	8 1/4"	10 3/8"	12 1/2"	16 1/8"	18 1/8"	18 1/8"	16 1/8"	16 1/8"	18 1/8"
D1	4"	4"	4"	4"	4 3/4"	4 3/4"	4 3/4"	4 3/4"	4 3/4"	4 3/4"
K	1'-9"	2'-0"	2'-0"	2'-0"	2'-2"	2'-4"	2'-4"	2'-4"	2'-4 1/2"	2'-11 1/2"
E	4 5/8"	4 5/8"	4 3/4"	4 3/4"	4 3/4"	5 3/4"	5 3/4"	5 3/4"	5 1/2"	5 1/2"
F	4 1/4"	4 1/4"	4 1/4"	4 1/4"	4 1/4"	5"	5"	5"	5"	5"
G	1/2"	1/2"	1/2"	1/2"	5/8"	5/8"	5/8"	5/8"	7/8"	7/8"
C	4"	4"	4"	4"	6"	6"	6"	6"	6"	6"
X	1 3/4"	1 3/4"	1 3/4"	1 3/4"	3"	3"	3"	3"	3"	3"
Y	1 1/2"	1 1/2"	1 1/2"	1 1/2"	2"	2"	2"	2 1/2"	2 1/2"	2 1/2"
Z	11/16"	11/16"	11/16"	11/16"	13/16"	13/16"	13/16"	15/16"	15/16"	15/16"
SWING LIMITS (TOP VIEW)	94°	94°	90°	90°	106°	96°	96°	90°	90°	90°

CLEARANCE DIMENSIONS MODEL J906FCT
 WALL BRACKET TYPE JIB CRANE

ABELL-HOWE CRANES
 DIVISION OF CRANE EQUIPMENT & SERVICE, INC.
 UNIT 100, 10321 WERCH DRIVE, WOODBRIDGE IL 60517

SCALE: NONE
 DRAWN BY: P.J.H.
 DATE: 7-11-2003

CHECKED BY: _____
 APPROVED BY: _____

SHEET NO. 1 OF 1

LUBRICATION & MAINTENANCE FOR JIB CRANES

The most economical way to maintain a Jib Crane and keep it in good operation condition is to lubricate all moving parts regularly.

Regular inspection of all parts should be made and all loose parts should be adjusted. Parts that become worn should be replaced at once.

The interval of lubrication varies as to the use of the machine. A crane operating twenty-four hours a day seven days a week needs lubricating once a week. Whereas a standard duty crane, operating eight hours a day on a five-day week should be lubricated every two to three weeks. Cranes under standby classification, being used once or twice a month, should be lubricated at least once every six months.

The actual interval from one lubrication to the next depends entirely upon the type and length of operation which the crane is subjected. This, of course, is variable and sometimes cannot be definitely determined. In this case, the crane operator or maintenance engineer would determine when the crane should be lubricated.

The top and bottom jib fittings are serviced by pressure type Alemite fittings that require lubrication. NLGI 1 and 2 greases are recommended for most applications where the jib's operating temperature range is between 0°F to 350°F (-18°C to 177°C).

STRUCTURAL BOLT TORQUE

1/2"Ø = 80 FT. LBS.

5/8"Ø = 155 FT. LBS.

3/4"Ø = 260 FT. LBS.

7/8"Ø = 345 FT. LBS.

1"Ø = 515 FT. LBS.

TAGLINE ASSEMBLY

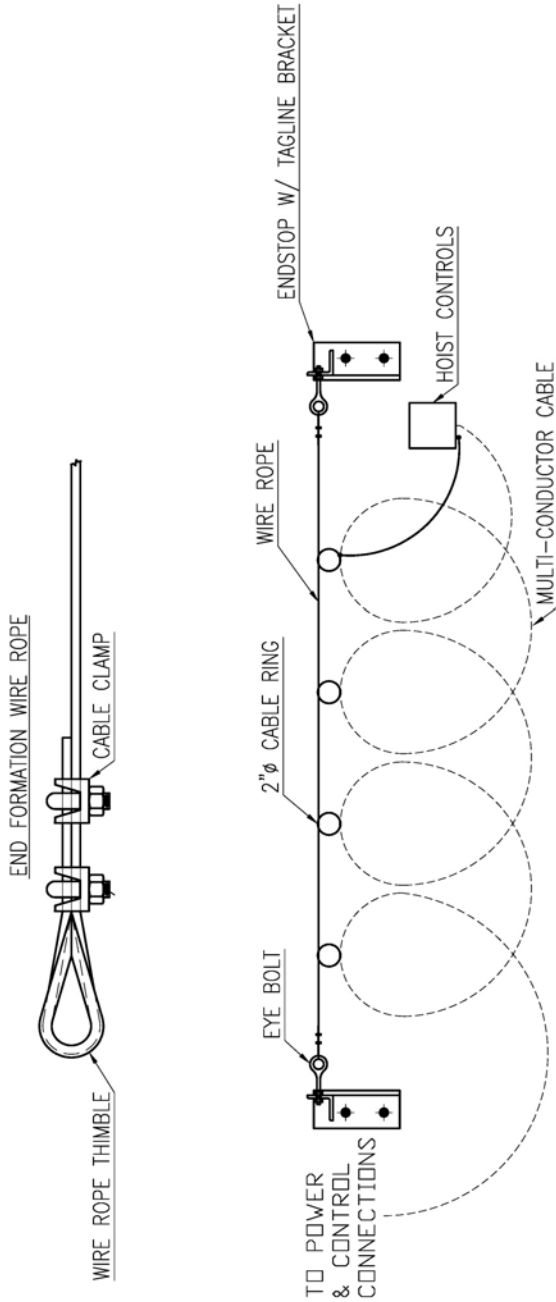

NOTE TO INSTALLER:

- 1) INSTALL ENDSTOP/TAGLINE BRACKETS.
- 2) FASTEN EYEBOLTS ON BRACKETS.
- 3) ASSEMBLE WIRE ROPE (AS SHOWN ABOVE) THROUGH EYEBOLT.
- 4) ATTACH OPTIONAL CONDUCTOR CORD TO CABLE RINGS/TROLLEYS- (APPROX 6' SPACING BETWEEN CABLE RINGS/TROLLEYS).
- 5) ADJ EYEBOLTS TO REMOVE SLACK IN WIRE ROPE.
- 6) ATTACH TOW CHAIN (ADJ. TO LENGTH).

TAGLINE PART # (ITEM #950)		BOOM SIZE
SPAN = UP TO 10 FEET	SPAN = 11 TO 15 FEET	SPAN = 16 TO 30 FEET
TAGLINE 10WFS		
TAGLINE 10W A		
TAGLINE 10W B		
	TAGLINE 15WFS	
	TAGLINE 15W A	
	TAGLINE 15W B	
	TAGLINE 20WFS	
	TAGLINE 20W A	
	TAGLINE 20W B	
	TAGLINE 25WFS (UP TO 25')	
	TAGLINE 30W A	
	TAGLINE 30W B	
		W6X16 & W8X21
		W10X26, W12X35 & W16X45
		W18X55, W21X57, W24X84 & W24X94
		W6X16 & W8X21
		W10X26, W12X35 & W16X45
		W18X55, W21X57, W24X84 & W24X94
		W6X16 & W8X21
		W16X45
		W18X55, W21X57, W24X84 & W24X94

SYL	REVISION	DATE	DRAWING PART #	TAGLINE & CONDUCTOR
			Customer:	
			Nameplate: STANDARD TAGLINES W/ 1/2" IZ CABLE AND ROUND TROLLEYS	
			Part No.: _____ Serial: _____ Sheet Number: _____ Date: 6/10/2013 File Name: _____ Checked By: _____ Date: _____ Draw. No.: _____ Approved By: _____ Date: _____ Revision: _____	
801 W. CENTER ST. (Rt 24) - BURMA, IL 61530 TELEPHONE: (309) 618-6000 - FAX: (309) 461-5118			1 of 1	

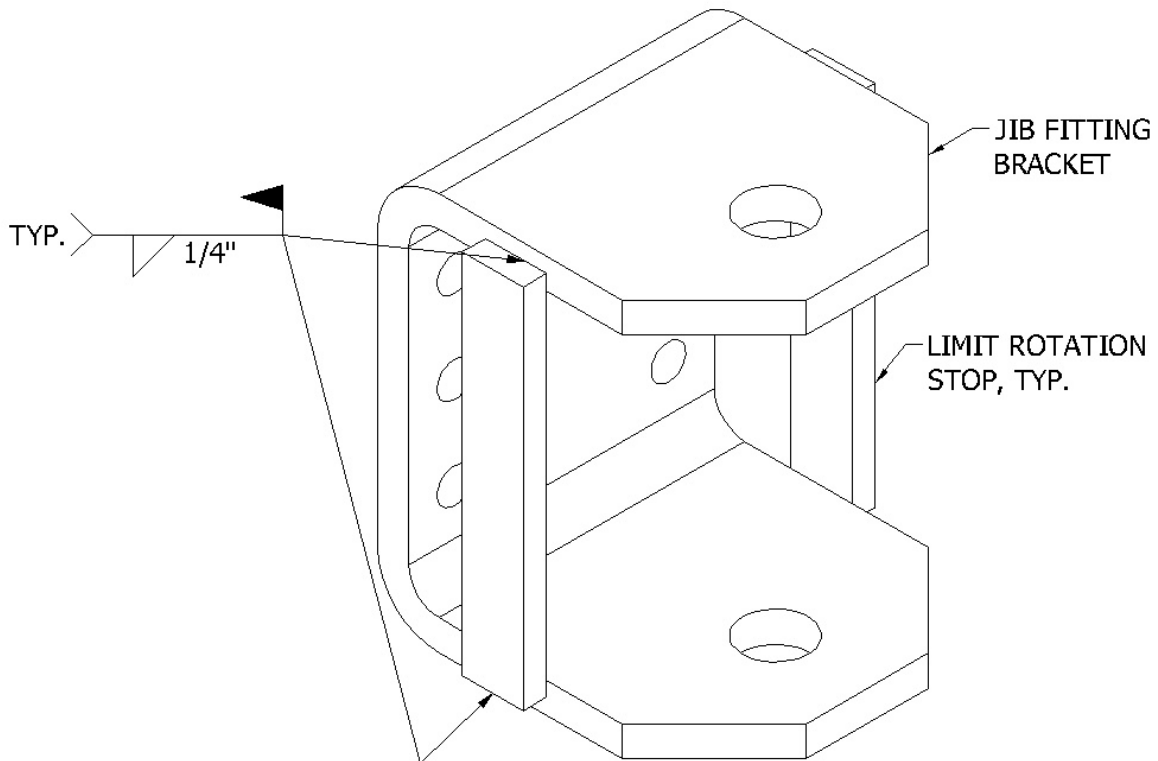

NOTES:

1. INDOOR USE ONLY
2. FOR THE 1F AND 2F MODELS ONLY
3. LIMIT ROTATION STOPS ARE FOR
4. LIMITING ROTATION, NOT STOPPING ROTATION.

			CES MATERIAL HANDLING <small>A COLUMBUS MCKINNON COMPANY</small> 801 W. CENTER ST., (RT 24) EUREKA, IL 61530 TELEPHONE: (309) 467-8282 TELEFAX: (309) 467-5118	Customer:	
				PROPRIETARY	
			Description: WELDING ROTATION STOPS		
REV	DESCRIPTION	DATE	Drawn By: DAC	Engr.: BNP	Sheet Number
<small>NOTICE TO PERSONS RECEIVING THIS DRAWING AND/OR TECHNICAL INFORMATION</small> CES claims proprietary rights in the material disclosed herein. This drawing and/or technical information is issued in confidence for engineering information only and may not be reproduced or used to manufacture a competing system or related product without direct permission from CES to the user. This drawing and/or technical information is loaned for mutual assistance and is subject to recall by CES at any time. This drawing and/or technical information is the property of CES.			Date: 11/2/2016	Scale: 1 / 2	D1
			File Name:		

REPLACEMENT PARTS: J906 WALL BRACKET JIB

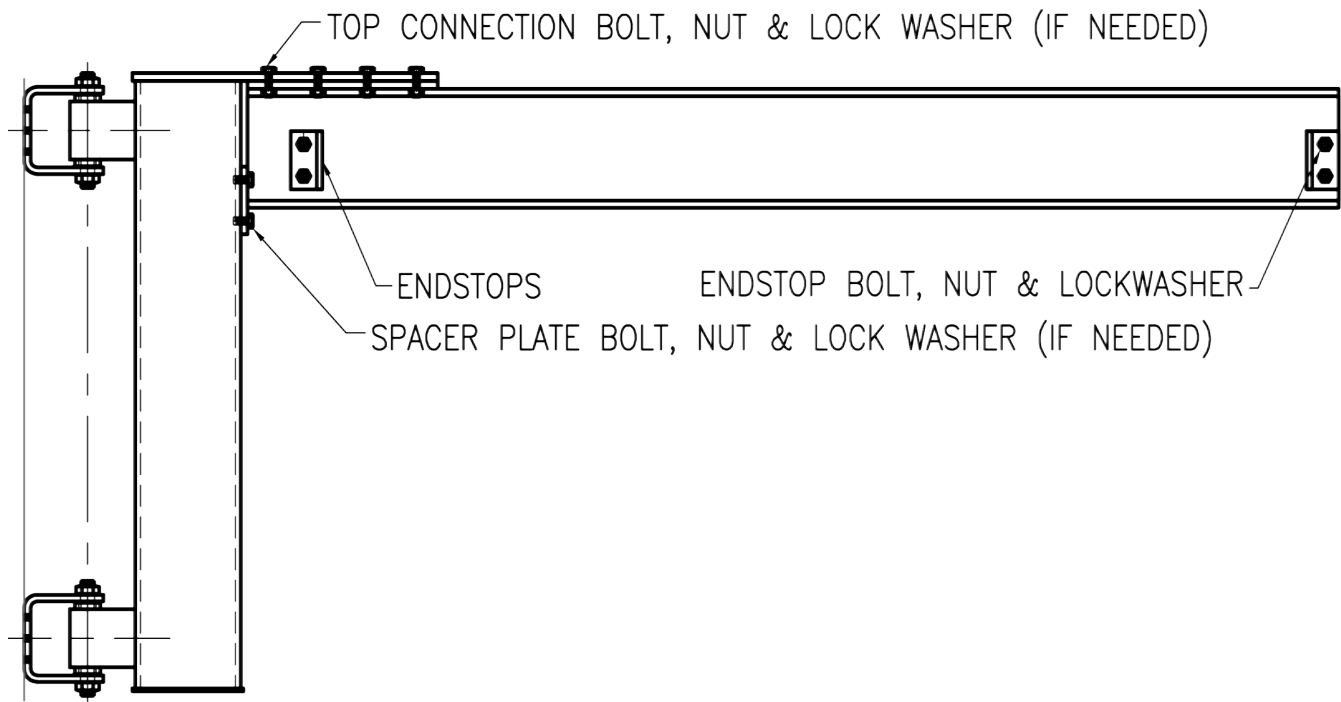

1F1A Boom Size	W6	W8	W10	W12	W16
(4) Endstops	805-22	805-22	805-3A	805-3A	805-3A
(4) Endstop Bolt	B0511016A	B0511016A	B0610026A	B0610026A	B0610026A
(4) Endstop Nut	N0511A	N0511A	N0610A	N0610A	N0610A
(4) Endstop Lock Washer	LW05H	LW05H	LW06H	LW06H	LW06H

2F1A Boom Size	W10	W12	W16	W18	W21
(4) Endstops	805-3A	805-3A	805-3A	805-4A	805-4A
(4) Endstop Bolt	B0610026A	B0610026A	B0610026A	B0610026A	B0610026A
(4) Endstop Nut	N0610A	N0610A	N0610A	N0610A	N0610A
(4) Endstop Lock Washer	LW06H	LW06H	LW06H	LW06H	LW06H

3F1A Boom Size	W16	W18	W21	W24
(4) Endstops	805-3A	805-4A	805-4A	805-4A
(4) Endstop Bolt	B0610026A	B0610026A	B0610026A	B0610026A
(4) Endstop Nut	N0610A	N0610A	N0610A	N0610A
(4) Endstop Lock Washer	LW06H	LW06H	LW06H	LW06H
(10) Top Conn. Bolt	NA	NA	B0808030A	B0808030A
(10) Top Conn. Nut	NA	NA	N0808A	N0808A
(10) Top Conn. Lock Washer	NA	NA	LW08H	LW08H
(4) Spacer Plate Bolt	NA	NA	B0511020A	B0511020A
(4) Spacer Plate Nut	NA	NA	LW05H	LW05H

SAFE OPERATING PROCEDURES (S.O.P.) FOR ABELL - HOWE JIB CRANES

Your crane has been given a no-load test of the various drive and control devices and equipment. When your crane is placed into service, Abell-Howe has no further control over its inspection, operation or maintenance. For this reason, safety in the field must remain the responsibility of the user.

Your firm should have safety rules peculiar to your industry and your facilities. Compare your rules with those we suggest and where they differ, adopt the more stringent methods of safe and proper use.

This data is intended to supplement your existing comprehensive operating and maintenance instructions for overhead traveling crane operators.

The following points are important to the safe operation, inspection and maintenance of our cranes.

CRANE OPERATOR

For your protection and that of your workers, assign an operator who is competent, experienced and licensed if required by law. Only properly appointed persons should operate your cranes and hoist. If you do not have an experienced operator we recommend that your trainee read the data herein, noting any special instructions and paying particular attention to the function and operation of each control. In addition to being alert and safety conscious, the operator should:

- 1) Be trained in crane operation.
- 2) Be aware of normal shop area practices and procedure.
- 3) Have good hearing and vision (with or without correction) and good depth perception.
- 4) Be in good health – not afflicted with known heart or other conditions causing loss of his ability to react.
- 5) BE CAREFULLY INSTRUCTED IN HIS DUTIES.
- 6) Have a substantial knowledge of methods of hooking onto loads.
- 7) Be made to understand that he is directly responsible for the safe operation of the crane or hoist. When he feels doubt as to safety, he should stop the crane and refuse to handle loads until safe conditions prevail.
- 8) Like an airline pilot, the crane operator must be at all times capable of handling the controls so as not to endanger the safety of other personnel or plant equipment. An operator must not eat, read, sleep or otherwise divert his attention while operating a crane. Practical jokes should be absolutely forbidden, and the use of alcohol or other intoxicants is not to be tolerated. An operator given a prescription drug by a physician should obtain written assurance it will not prevent him from operating the crane or hoist in a safe manner, before returning to work.

INSPECTION & MAINTENANCE

GENERAL

A periodic inspection, lubrication and maintenance schedule should be established for cranes and hoists, to be carefully followed to prevent minor defects from becoming more dangerous, as well as more costly to repair.

Quite often identical cranes or hoists will operate under widely varying duty cycles. It is therefore, impossible for a manufacturer to set up a definite maintenance time schedule for cranes. We recommend in the following paragraphs minimum safe intervals for average conditions, as there is no substitute for direct knowledge of local operating frequencies. Inspections are recommended at the times outlined in the following paragraphs.

DAILY

At the beginning of each shift, inspection should be made to assure that the crane or hoist is safe for immediate use, and should include, but not be limited to, the following:

- 1) Know that the equipment is adequately lubricated.
- 2) By operating each control, be sure it is working properly. If not, report to your supervisor, and advise the next operator so he can check to see the defect is taken care of.
- 3) Check all brakes for proper adjustment. The electric motor (holding) brakes are tested by lifting a capacity (or near capacity) load a short distance off the floor and suspending it by the brake.
- 4) Visually inspect each component of the crane or hoist normally used in lifting, traveling or lowering the load. Such inspection should include, but not limited to, the following:
 - a. Wire rope. Inspect for kinks or broken wire and replace damaged rope immediately. If chain type hoist, check to make sure chain is not deformed (usually by overload lifts) and replace if necessary.
 - b. Check all basic operating mechanisms such as sheaves, drums and brakes, and all safety devices such as upper and lower limit switches, travel limit switches, main line disconnects, overload cutouts, etc.
 - c. Scan the entire crane for signs of damage which might cause unsafe operation.

The above procedure should take only a few minutes at beginning of the shift and should help prevent "surprises".

MONTHLY

The inspection is intended to determine the need for repairs necessary to keep the crane and hoist in approximately new condition insofar as safety is involved and to find and correct any wear, damage or defect which could affect the safe operation of your crane or hoist. We suggest that results of this inspection be recorded by your maintenance or safety inspector maintaining a "log" on each unit. Such inspection should include the items listed under the daily inspection as well as the following:

- 1) Inspect the entire crane for possible structural damage.
- 2) Inspect for cracked or worn sheaves, drums, wheels and rails.
- 3) Inspect for worn, cracked or distorted components such as pins, bearings, shafts and gears.
- 4) Inspect for excessive wear on brake system parts, linings, pawls, and ratchets. Make sure mechanical load brake parts operate properly, are in good condition, and are properly lubricated.
- 5) Inspect all motors, controls and conductor systems which might in any way affect the safe operation of the equipment.
- 6) Oil or grease on the equipment can cause serious falls, and dirt in mechanical parts will cause excessive wear and possible failure. Keep the crane clean and in good working order.
- 7) Replace protective guards and panels before operating the crane or hoist.

SPECIAL NOTE: OSHA & ASME B30 STANDARDS HAVE SPECIFIC REQUIREMENTS FOR CRANE & HOIST INSPECTIONS. PLEASE ENSURE YOU ARE FOLLOWING THESE REQUIREMENTS.

INSPECTION AS REQUIRED

The third inspection should be made as individual incidents occur, which apply sudden and unusual shock loads, unusual stress, or possible damage of any type to the equipment. Whenever an incident of this type occurs, it is the responsibility of the operator to report such to his supervisor, so an immediate inspection testing and any required repairs can be made.

SAFE OPERATING

Your crane operators should be instructed in the mechanics of operating a crane safely. Some suggestions follow:

- 1) Before leaving the control station of the crane, the following precautions must be observed.
 - a. Stop the crane at the approved location for entering or leaving the crane if cab controlled, or parking location if push button control.
 - b. Lower the load to the ground.

SPECIAL NOTE - NEVER DEPEND ON A HOLDING BRAKE TO SUSPEND A LOAD UNLESS THE OPERATOR IS AT THE CONTROLS, IN A POSITION TO HANDLE THE LOAD.

- c. Raise all hooks to the upper limit switch.
 - d. Place all controls in the OFF position.
 - e. Place the main power switch or button to OFF position.
 - f. Make a visual check for any abnormal or dangerous condition.
- 2) The operator or person in charge should see that:
 - a. Slings are adequate, properly arranged for load and secured before load is lifted.
 - b. All loose items such as tools are removed from both load and crane before lift is made.
 - c. Keep load away from obstructions while lifting or traveling.
 - d. Avoid sudden starts and stops. Bumping into runway stops is prohibited.
 - e. Make sure hoist line is vertical before lifting, slack in the line is to be removed slowly, and all workers are clear before beginning the lift.
 - f. Do not pass load over the heads of workers. Non-operating personnel should be warned to leave the immediate area when making lifts.
 - g. Do not allow anyone to ride the hook.
 - h. ALL stop signals are obeyed, regardless of who gives them.
 - i. Other than emergency stop signals, signals are accepted from only one designated person at a time unless special arrangements are made in advance for a specific lift only.
 - k. Standard crane signals are used and loads are not moved unless the standard signal is given, seen and understood. See Fig. 1.
- 3) Never attempt to adjust, repair or lubricate moving crane.
- 4) Do NOT use a crane for side pulling. It was not designed nor intended for such use. This practice may cause electrical as well as mechanical damage and will endanger personnel.
- 5) If a rope has been allowed to become slack, make sure that the rope is properly seated in the drum grooves and in the sheaves before a load is lifted.
- 6) Never lower the load block to a point where less than two full wraps remain on the drum. If all cable is removed from the drum, be sure it is rewound in the correct direction to prevent cable damage and to insure correct operation of the hoist limit switches.

7) Never block out safety devices, such as limit switches, in order to allow operation of the crane in a manner not intended by the manufacturer.

SPECIAL NOTE - LIMIT SWITCHES ARE SAFETY DEVICES, NOT OPERATING CONTROLS. NEVER ACTUATE THEM UNNECESSARILY DURING NORMAL OPERATION.

8) The following general procedure should be used when checking limit switches:

a. Move crane to an open area, away from personnel and other equipment.

b. Make sure no load is on the hoist.

c. Slowly run the hook block up to about three feet (3') below the limit switch weight (or paddle) and stop hoist motion.

d. Proceed to raise the hook block at lowest speed until it contacts the trip mechanism - if the limit switch device does not cut out the upward travel as it should, lower hook block out of contact and notify your supervisor at once.

9) If electrical power fails, place all controllers in the OFF position and keep them there until power is restored. This will prevent sudden and unexpected movement when power is restored.

10) Never remove a DO NOT OPERATE card from a control without checking to see that it is safe to do so, even if you have placed the card yourself. Someone else may be depending on that card to prevent the crane from being operated.

11) Use fuses of specified size, and NEVER use a "cheater" fuse. Blown fuses are both a sign of trouble and the main protection afforded the electrical system.

12) NEVER contact another crane on the same runway. If it is necessary be sure all personnel in the area are so advised and push at slowest possible speed. Never move or bump a crane displaying a warning flag or sign.

IMPORTANT:

NEVER EXCEED THE RATED CAPACITY OF THE CRANE OR HOIST. Be sure to include weight of "below the hook" devices and motorized rotating hook block when figuring weight of load lifted.

IMPORTANT:

While inspecting or work of any kind is being performed on a crane or hoist, a warning flag should be placed where it is readily visible to indicate the crane or hoist must not be moved. The main power source must be LOCKED in the OFF position.





IMPORTANT:

Repairs and adjustments should be made only by properly designated and authorized personnel. When a crane is being repaired, the maintenance person assigned is in charge of all phases of crane movement and operation, and his or her instructions should ordinarily be obeyed without question. Only if the instructions are contrary to safe operating practices should the operator question them. Whenever this occurs, the maintenance supervisor should be contacted at once for a decision.

ABOVE ALL, USE COMMON SENSE!

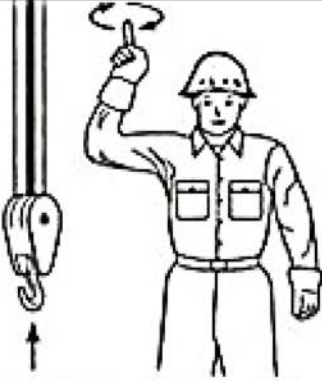
The manufacturer strives to build safe equipment for your use, but SAFETY MUST BE A FRAME OF MIND WHEN IT COMES TO ACTUAL OPERATION.

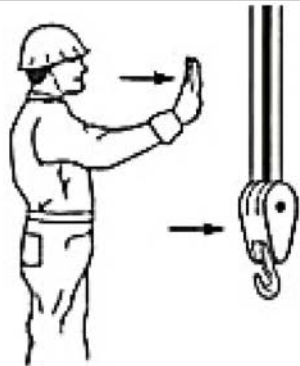
STANDARD HAND SIGNALS (FIG. 1)

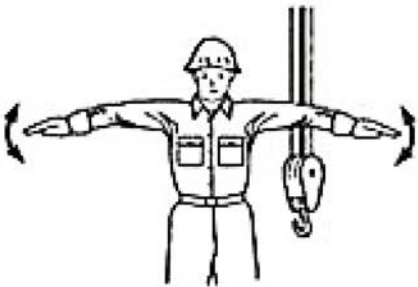
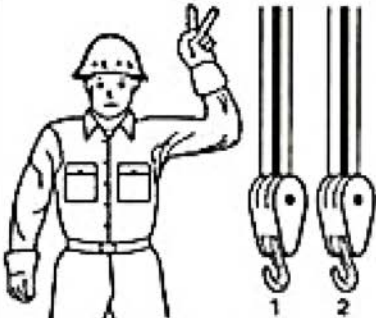
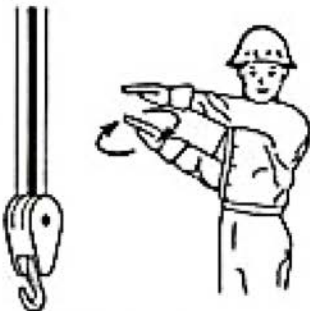
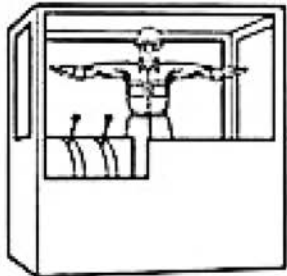
 <p>HOIST. WITH FOREARM VERTICAL, FOREFINGER POINTING UP, MOVE HAND IN SMALL HORIZONTAL CIRCLE.</p>	 <p>LOWER. WITH ARM EXTENDED DOWNWARD, FOREFINGER POINTING DOWN, MOVE HAND IN SMALL HORIZONTAL CIRCLE.</p>	 <p>BRIDGE TRAVEL. ARM EXTENDED FORWARD, HAND OPEN AND SLIGHTLY RAISED, MAKE PUSHING MOTION IN DIRECTION OF TRAVEL.</p>
 <p>TROLLEY TRAVEL. PALM UP, FINGERS CLOSED, THUMB POINTING IN DIRECTION OF MOTION, JERK HAND HORIZONTALLY.</p>	 <p>STOP. ARM EXTENDED, PALM DOWN, MOVE ARM BACK AND FORTH HORIZONTALLY.</p>	 <p>EMERGENCY STOP. BOTH ARMS EXTENDED, PALMS DOWN, MOVE ARMS BACK AND FORTH HORIZONTALLY.</p>
 <p>MULTIPLE TROLLEYS. HOLD UP ONE FINGER FOR BLOCK MARKED "1" AND TWO FINGERS FOR BLOCK MARKED "2". REGULAR SIGNALS FOLLOW.</p>	 <p>MOVE SLOWLY. USE ONE HAND TO GIVE ANY MOTION SIGNAL AND PLACE OTHER HAND MOTIONLESS IN FRONT OF HAND GIVING THE MOTION SIGNAL. (HOIST SLOWLY SHOWN AS EXAMPLE.)</p>	 <p>MAGNET IS DISCONNECTED. CRANE OPERATOR SPREADS BOTH HANDS APART WITH PALMS UP.</p>

ABELL-HOWE JIB CRANE SAFETY

JIB CRANE SAFETY "DO'S"

- DO Read and follow all Federal, State, Local, and Company safety procedures especially OSHA 1910.179, 1910.181, and ANSI B30.17 and B30.20.
- DO Read and follow all safety procedures of lifting devices, i.e. Hoist or Winch, Slings, Ropes, Chains, Magnets, Grabs, etc.
- DO Become familiar with all controls, latches, switches, etc.
- DO Warn personnel of approaching load.
- DO Keep all body parts clear of vertical and horizontal pinch or crush points when lifting, lowering, and/or traversing the load.
- DO Check to insure the load is properly balanced and will not slip or shift.
- DO Keep work area clear of obstacles.
- DO Perform regular inspections, maintenance, and lubrication on jib crane.
- DO Understand that most accidents are caused by human error and therefore can be prevented through knowledge training inspection, maintenance, common sense, planning ahead, communication, and attentiveness.

JIB CRANE SAFETY "DON'TS"

- DON'T Exceed rated capacity of Jib Crane.
- DON'T Move or suspend the load over people.
- DON'T Allow people to stand or pass under a load.
- DON'T Move load with people on the hook or on the load.
- DON'T Allow load to contact any obstructions.
- DON'T Leave load suspended in the air unattended.
- DON'T Side pull or try to lift loads past the span (reach) of the Jib Crane.
- DON'T Operate Jib Crane if any parts are bent, cracked, damaged, missing or non-functional.
- DON'T Operate Jib Crane unless you are qualified.
- DON'T Place ladders or climbing devices against jib crane without securing boom rotation.
- DON'T Remove boom end stops without securing trolley travel.

NOTES:



ABELL-HOWE



Jib Crane Product Solutions

- J906FC Series – Wall Mounted Full Cantilever Jib Cranes
- J904B Series – Heavy Duty Base Mounted Pillar Jib Cranes
- J904F Series – Heavy Duty Foundation Mount Pillar Jib Cranes
- J904S Series – Light Duty Base Mounted Jib Cranes
- J904L Series – Foundationless Jib Cranes
- J902FC Series – Mast Style Jib Cranes
- J900 Series – Wall Bracket Jib Cranes
- Electric & Hand Geared Motorized Rotation Jib Cranes
- Jib Crane Fittings
- Custom Designed & Engineered Jib Cranes

Abell-Howe Company has been designing, engineering, manufacturing and erecting overhead material handling systems for over 100 years. Known for our extensive product line and engineering skills, Abell-Howe provides both standardized cranes, as well as the expertise to design most any type of crane to meet the ever-changing needs of the end user.

Abell-Howe is a member of CMAA and is on the committee that establishes standards for mechanical, structural, and electrical design of cranes. These engineering innovations and improvements are incorporated into every crane we manufacture, assuring product reliability, safety, efficiency and cost effectiveness.

Crane Equipment & Service, Inc. Manufacturer of Abell-Howe™ Cranes
801 W. Center St, Eureka, IL 61530

800.548.2930 | www.AbellHowe.com

